

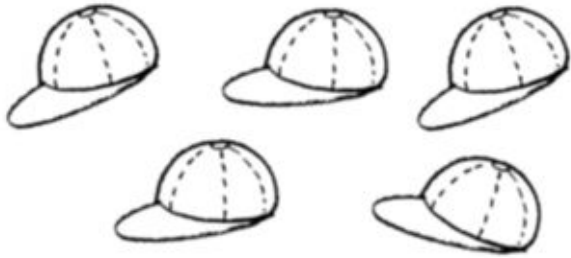

Números a la carta

Nombre _____ Fecha _____

1 Cuenta y rodea el número.



3 5 7

2 4 6

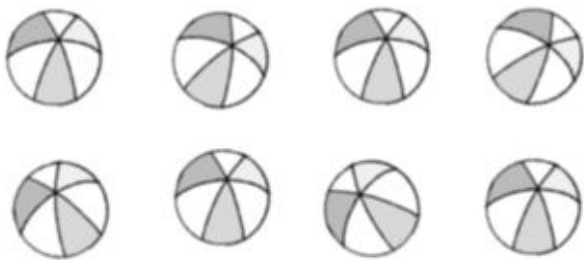

6 7 8



1 4 8

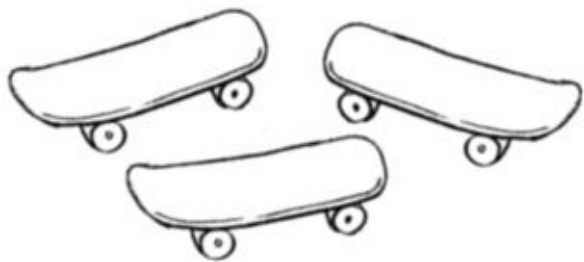

3 6 9

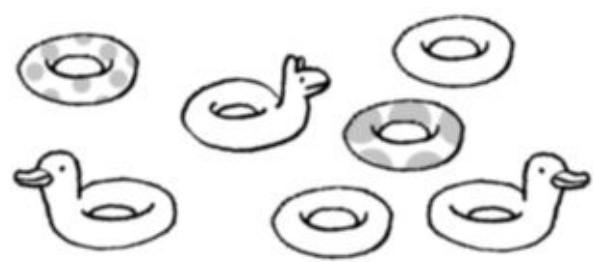

5 6 7

2 Completa.

0 ▶ 1 ▶ 2 ▶ ▶ ▶ ▶ ▶ ▶ ▶ 9

9 ▶ 8 ▶ 7 ▶ ▶ ▶ ▶ ▶ ▶ ▶ 0

Nombre _____ Fecha _____

1 Observa y completa.



$$\boxed{4} + \boxed{5} = \boxed{9}$$



$$\boxed{} + \boxed{} = \boxed{}$$



$$\boxed{} + \boxed{} = \boxed{}$$



$$\boxed{} + \boxed{} = \boxed{}$$



$$\boxed{} + \boxed{} = \boxed{}$$

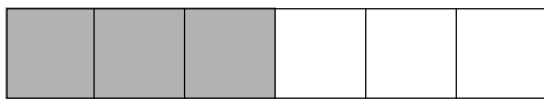

$$\boxed{3} + \boxed{} = \boxed{}$$



$$\boxed{} + \boxed{} = \boxed{}$$



$$\boxed{} + \boxed{} = \boxed{}$$



$$\boxed{} + \boxed{} = \boxed{}$$



$$\boxed{} + \boxed{} = \boxed{}$$

Nombre _____ Fecha _____

1 Escribe los números y suma.



$$\boxed{2} + \boxed{} = \boxed{3}$$

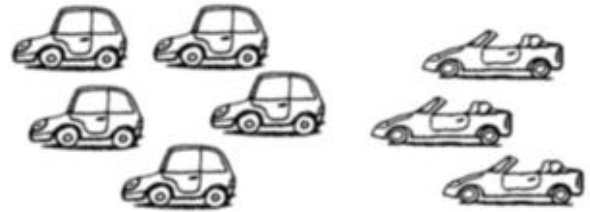

$$\boxed{} + \boxed{} = \boxed{}$$

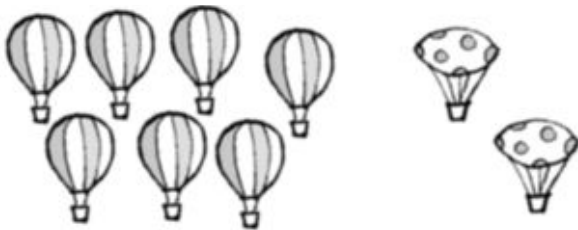

$$\boxed{} + \boxed{} = \boxed{}$$



$$\boxed{} + \boxed{} = \boxed{}$$

2 Dibuja y suma.

$$3 + 2 = \boxed{}$$



$$3 + 3 = \boxed{}$$

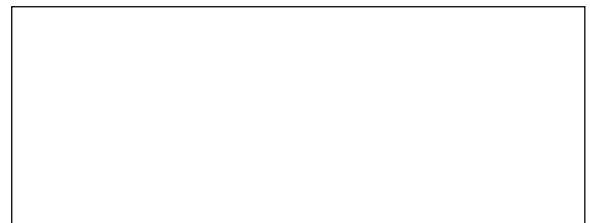

$$4 + 2 = \boxed{}$$

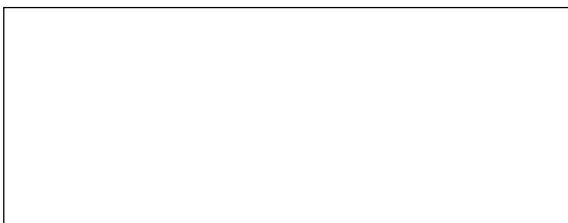

$$6 + 2 = \boxed{}$$

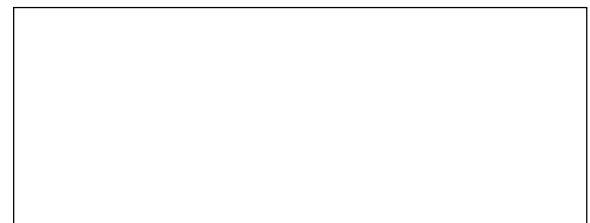

Nombre _____ Fecha _____

1 Completa.

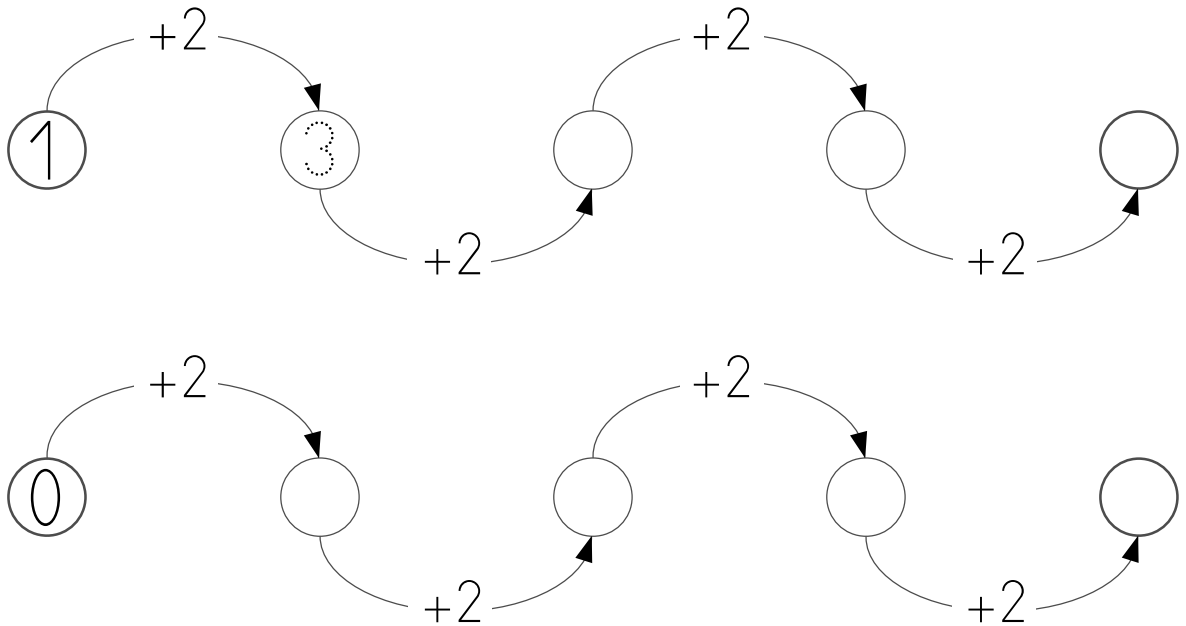

2 Completa.

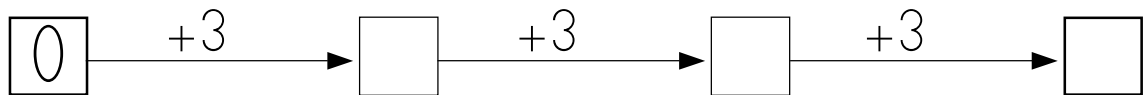
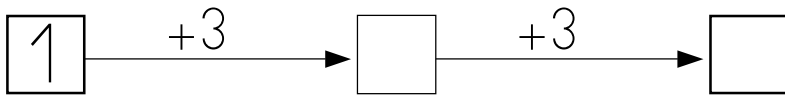

3 Escribe los números que faltan.

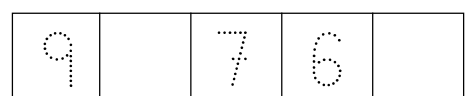
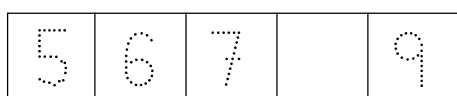
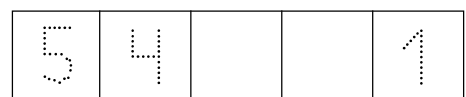
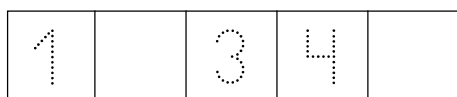

Nombre _____ Fecha _____

1 Rodea 10 en cada grupo y completa.

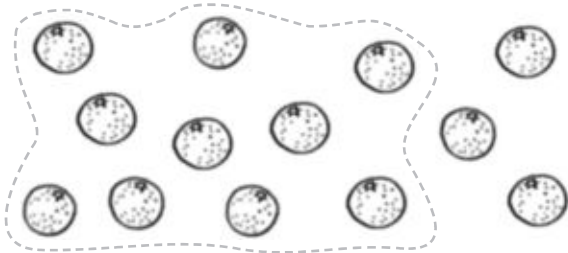

$$10 + \boxed{3} = \boxed{13}$$

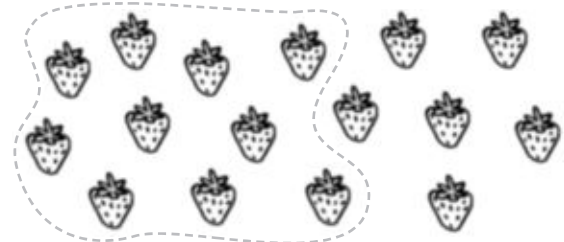

$$10 + \boxed{} = \boxed{}$$

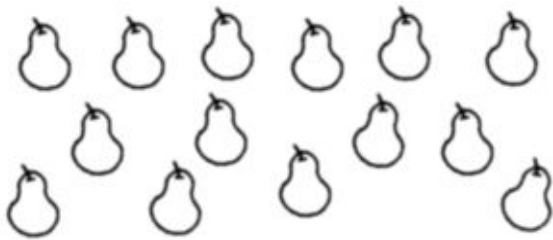

$$10 + \boxed{} = \boxed{}$$

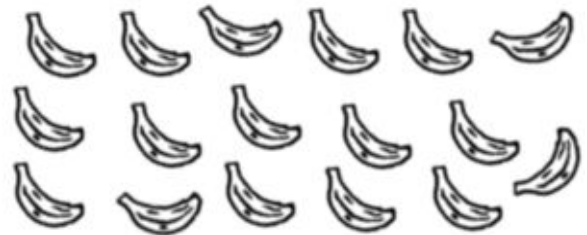

$$10 + \boxed{} = \boxed{}$$

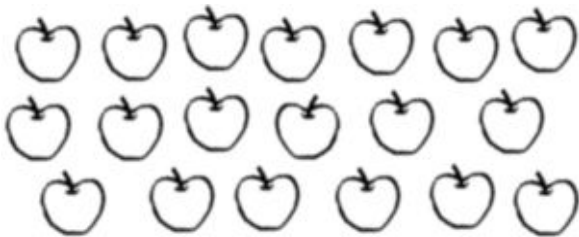

$$10 + \boxed{} = \boxed{}$$

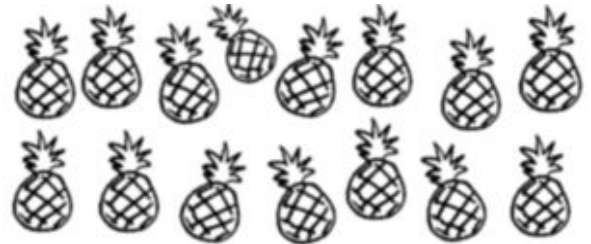

$$10 + \boxed{} = \boxed{}$$

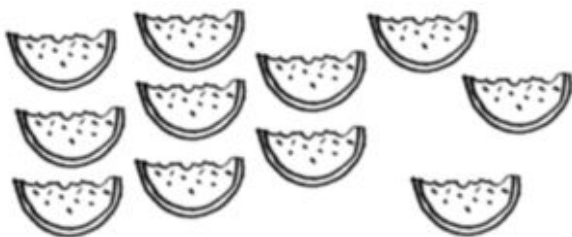

$$10 + \boxed{} = \boxed{}$$

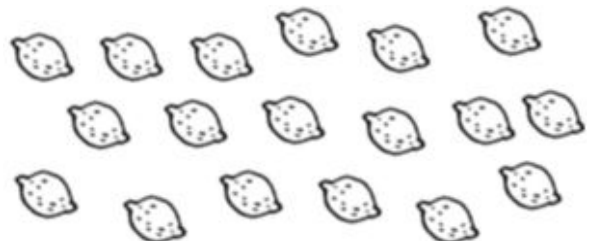

$$10 + \boxed{} = \boxed{}$$

Nombre _____ Fecha _____

1 Completa.

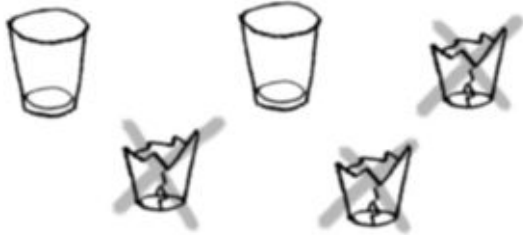

$$\boxed{5} - \boxed{3} = \boxed{2}$$



$$\boxed{} - \boxed{} = \boxed{}$$

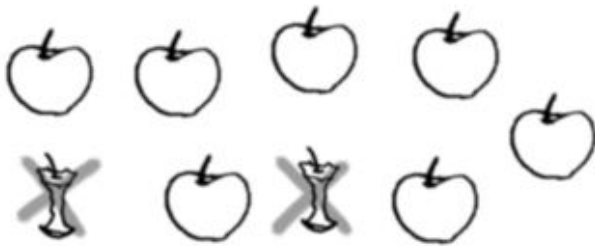

$$\boxed{} - \boxed{} = \boxed{}$$



$$\boxed{} - \boxed{} = \boxed{}$$

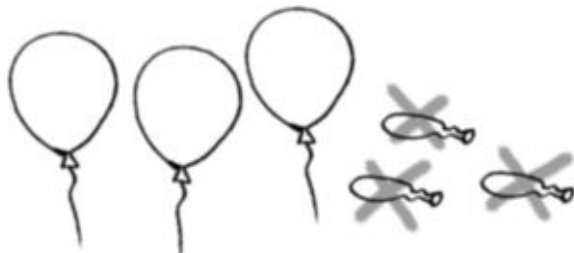

$$\boxed{} - \boxed{} = \boxed{}$$



$$\boxed{} - \boxed{} = \boxed{}$$



$$\boxed{} - \boxed{} = \boxed{}$$

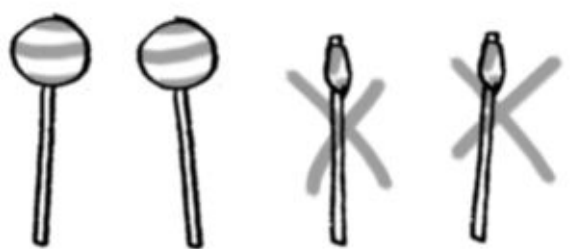

$$\boxed{} - \boxed{} = \boxed{}$$

Nombre _____ Fecha _____

1 Suma.

$5 + 4 = \square$

$7 + 3 = \square$

$4 + 2 = \square$

$6 + 2 = \square$

$5 + 2 = \square$

$5 + 1 = \square$

$4 + 3 = \square$

$7 + 1 = \square$

$6 + 4 = \square$

$4 + 1 = \square$

$8 + 2 = \square$

$5 + 0 = \square$

$7 + 2 = \square$

$5 + 3 = \square$

$6 + 1 = \square$

$3 + 0 = \square$

$6 + 3 = \square$

$9 + 1 = \square$

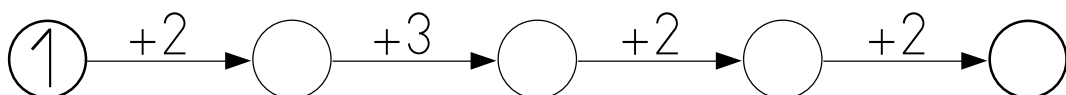
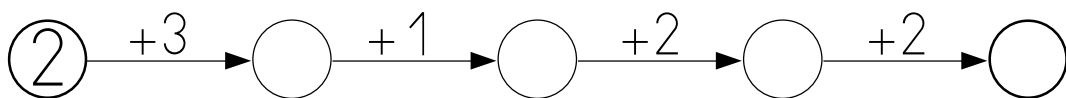
2 Completa.

Nombre _____ Fecha _____

1 Completa.

0

1

2

3

4

5

6

7

8

9

10

11

12

13

14

15

16

17

18

19

2 Une.

quince

ocho

once

dieciséis

11

15

16

8

Nombre _____ Fecha _____

1 Completa.

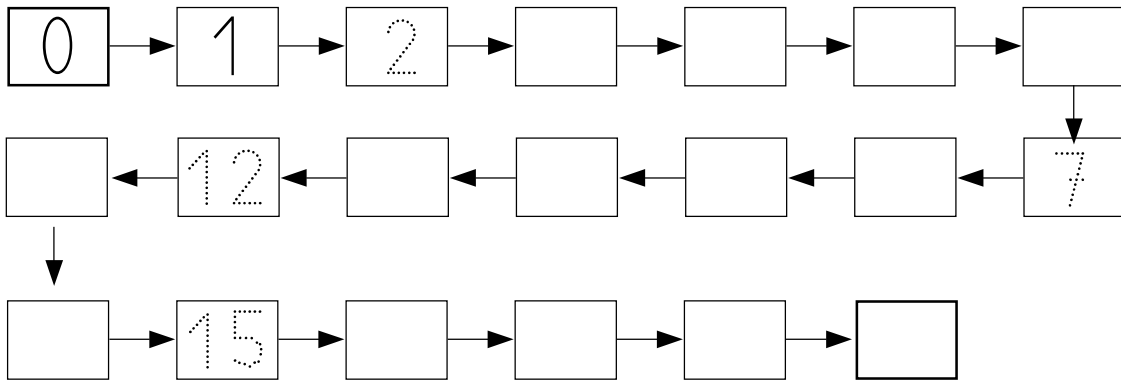

2 Suma.

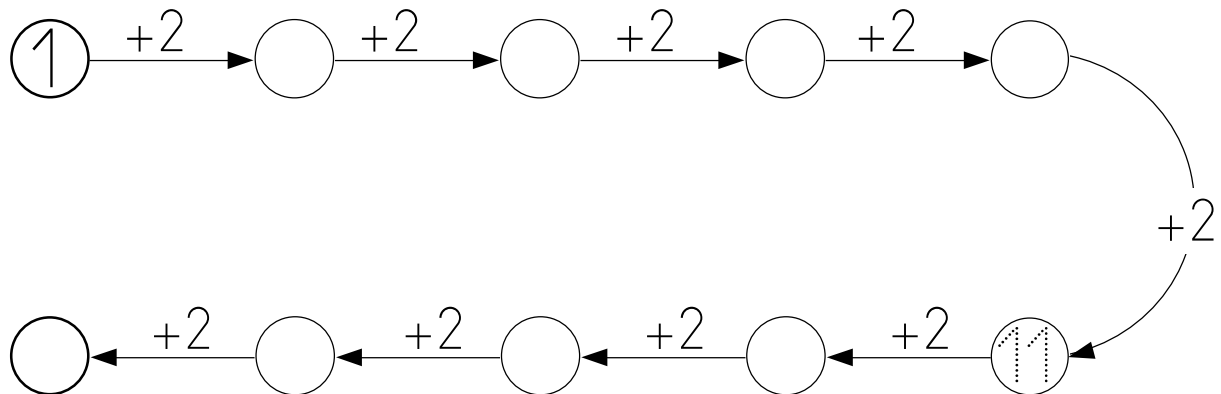
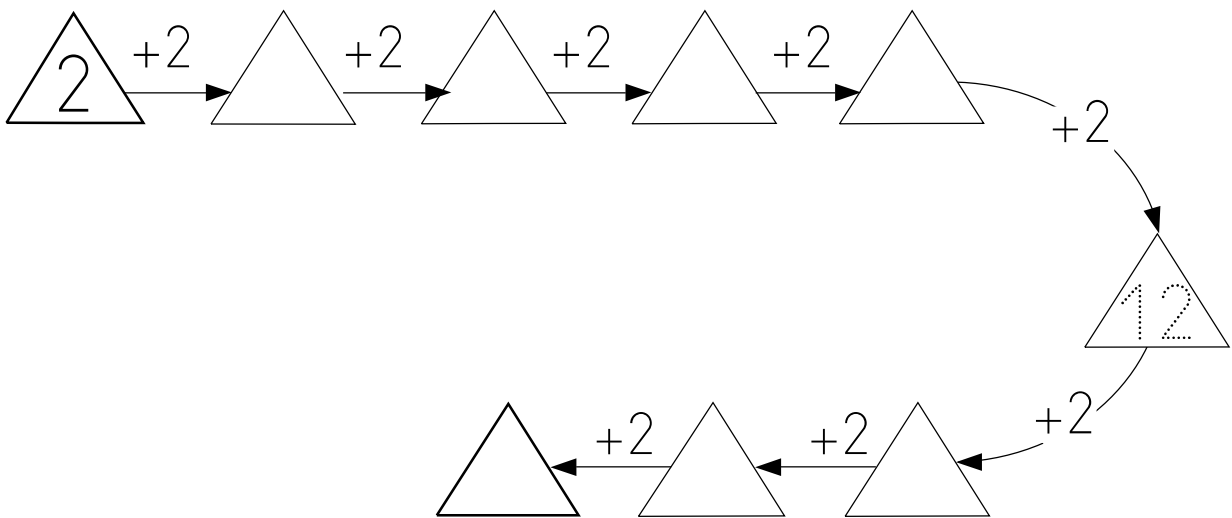

Nombre _____ Fecha _____

1 Suma.

$15 + 4 = \square$

$5 + 5 = \square$

$8 + 3 = \square$

$9 + 5 = \square$

$11 + 6 = \square$

$18 + 1 = \square$

$12 + 3 = \square$

$17 + 2 = \square$

$6 + 4 = \square$

$14 + 2 = \square$

$12 + 6 = \square$

$10 + 8 = \square$

$8 + 4 = \square$

$16 + 3 = \square$

$7 + 4 = \square$

$16 + 2 = \square$

$10 + 4 = \square$

$13 + 5 = \square$

$13 + 3 = \square$

$14 + 5 = \square$

$16 + 1 = \square$

$10 + 5 = \square$

$7 + 6 = \square$

$15 + 2 = \square$

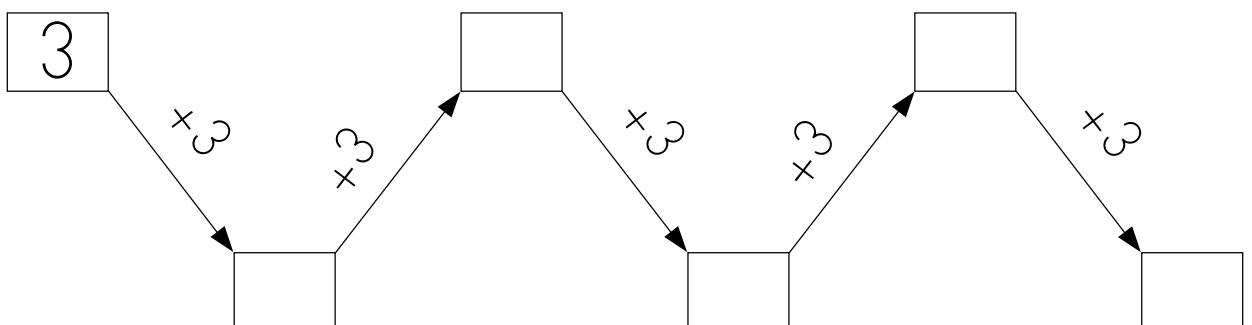
2 Completa.

Nombre _____ Fecha _____

1 Completa.

10 diez

20 veinte

30

40

50

60

70

80

90

2 Completa.

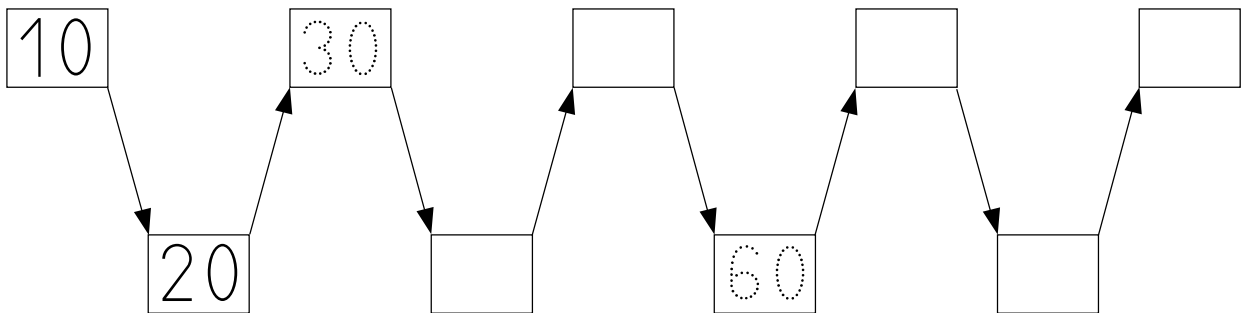

3 Une.

veinte

cuarenta

sesenta

setenta

60

70

10

20

50

40

30

80

Nombre _____ Fecha _____

1 Resta.

$6 - 4$ 1 2 3 4 5 6 7 8 9 $6 - 4 = 2$

$7 - 5$ 1 2 3 4 5 6 7 8 9 $7 - 5 = \square$

$5 - 4$ 1 2 3 4 5 6 7 8 9 $5 - 4 = \square$

$7 - 2$ 1 2 3 4 5 6 7 8 9 $7 - 2 = \square$

$4 - 1$ 1 2 3 4 5 6 7 8 9 $4 - 1 = \square$

$8 - 3$ 1 2 3 4 5 6 7 8 9 $8 - 3 = \square$

$9 - 6$ 1 2 3 4 5 6 7 8 9 $9 - 6 = \square$

$3 - 2$ 1 2 3 4 5 6 7 8 9 $3 - 2 = \square$

$6 - 3$ 1 2 3 4 5 6 7 8 9 $6 - 3 = \square$

Nombre _____ Fecha _____

1 Completa y suma.

$$4 + 2 + 2 = \square$$
$$6 + 2 = \square$$

$$6 + 2 + 3 = \square$$
$$\square + \square = \square$$

$$5 + 3 + 4 = \square$$
$$\square + \square = \square$$

$$3 + 3 + 5 = \square$$
$$\square + \square = \square$$

$$8 + 7 + 4 = \square$$
$$\square + \square = \square$$

$$7 + 3 + 4 = \square$$
$$\square + \square = \square$$

2 Suma.

$$5 + 1 + 3 = \square$$

$$5 + 2 + 3 = \square$$

$$6 + 1 + 2 = \square$$

$$4 + 2 + 5 = \square$$

$$4 + 3 + 3 = \square$$

$$9 + 1 + 7 = \square$$

Nombre _____ Fecha _____

1 Completa.

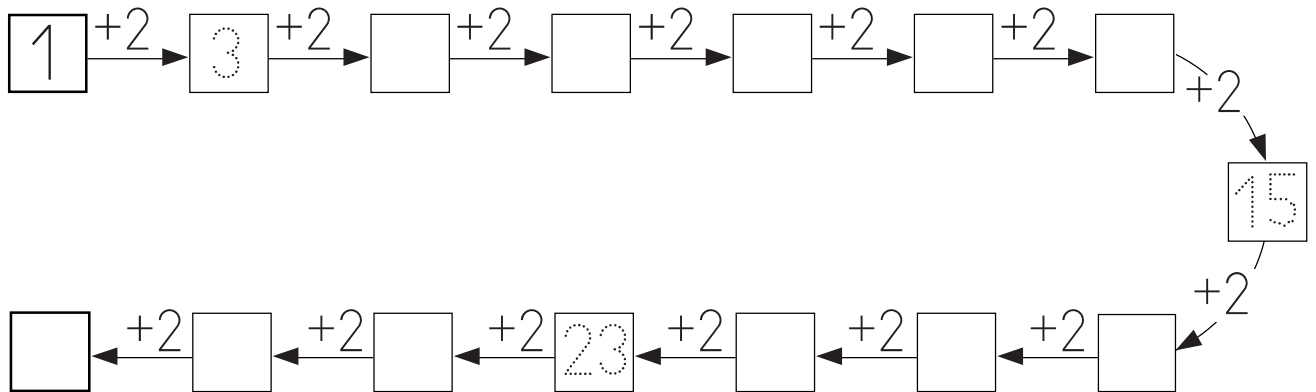

2 Completa.

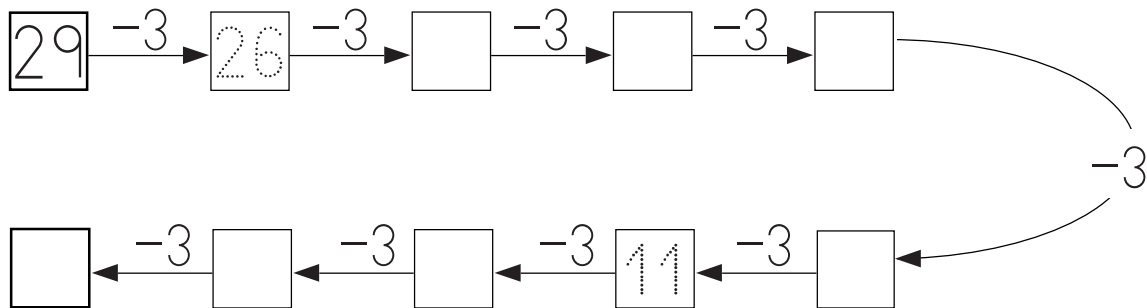

3 Completa.

Decenas	Unidades	=		Decenas	Unidades
1	7	=	17	26	= 2 6
2	3	=	\square	12	= \square \square
2	8	=	\square	21	= \square \square
1	4	=	\square	20	= \square \square

Nombre _____ Fecha _____

1 Completa.

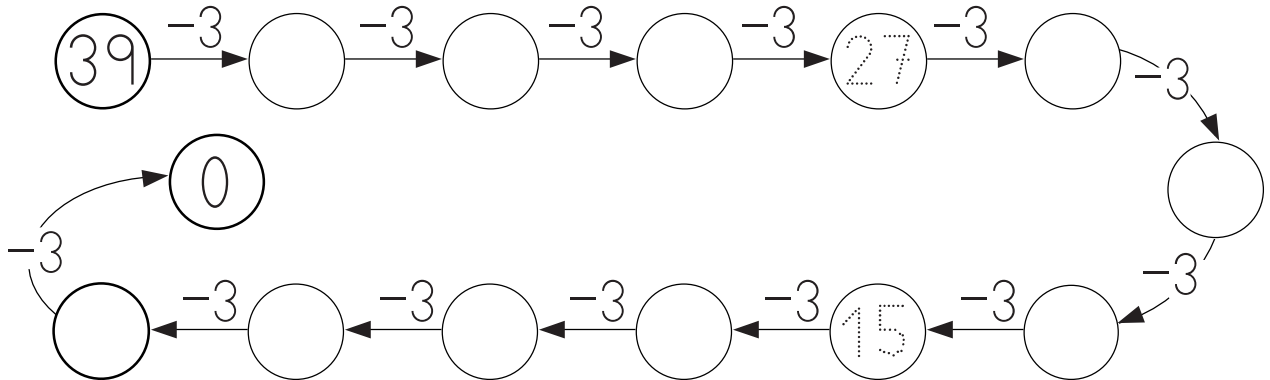

2 Completa.

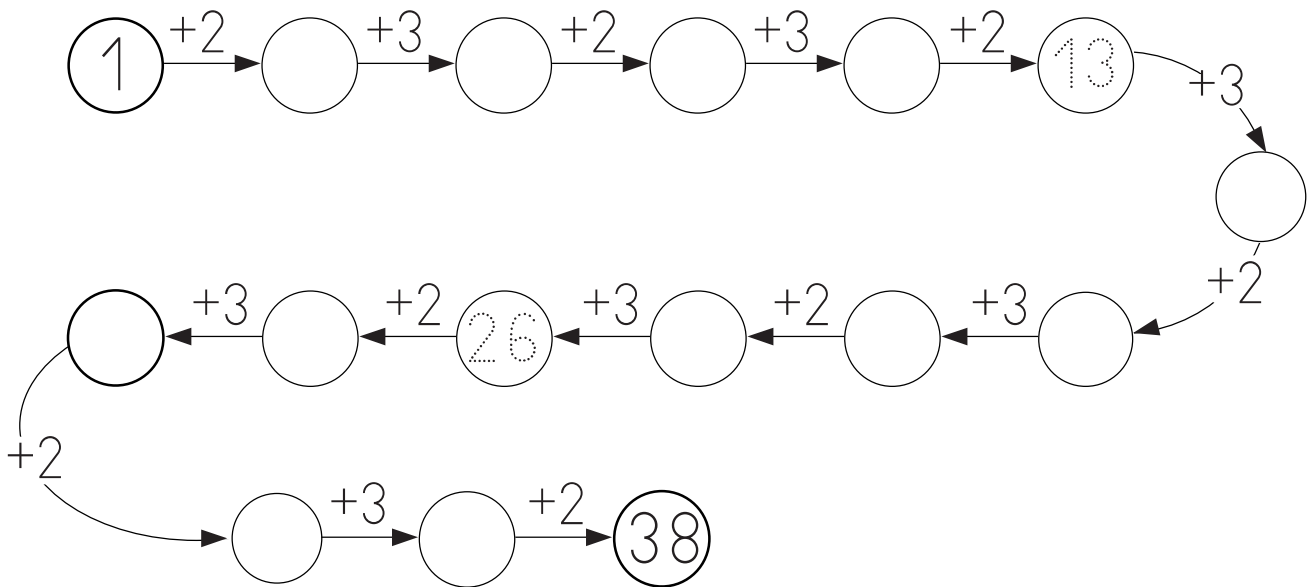

3 Escribe el número que falta.

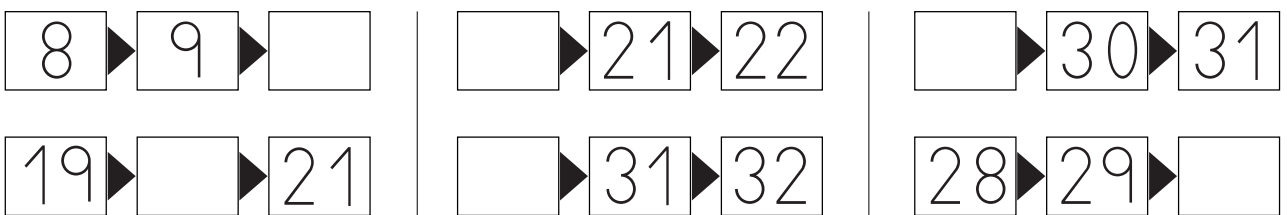

Nombre _____ Fecha _____

1 Cuenta y completa las restas.

$$15 - 9 = \boxed{6}$$

1	2	3	4	5	6	7	8	9	10	11	12	13	14	15	16	17	18	19
---	---	---	---	---	---	--------------	--------------	--------------	---------------	---------------	---------------	---------------	---------------	---------------	----	----	----	----

$$11 - 5 = \square$$

1	2	3	4	5	6	7	8	9	10	11	12	13	14	15	16	17	18	19
---	---	---	---	---	---	---	---	---	----	----	----	----	----	----	----	----	----	----

$$13 - 8 = \square$$

1	2	3	4	5	6	7	8	9	10	11	12	13	14	15	16	17	18	19
---	---	---	---	---	---	---	---	---	----	----	----	----	----	----	----	----	----	----

$$14 - 7 = \square$$

1	2	3	4	5	6	7	8	9	10	11	12	13	14	15	16	17	18	19
---	---	---	---	---	---	---	---	---	----	----	----	----	----	----	----	----	----	----

$$12 - 8 = \square$$

1	2	3	4	5	6	7	8	9	10	11	12	13	14	15	16	17	18	19
---	---	---	---	---	---	---	---	---	----	----	----	----	----	----	----	----	----	----

$$19 - 12 = \square$$

1	2	3	4	5	6	7	8	9	10	11	12	13	14	15	16	17	18	19
---	---	---	---	---	---	---	---	---	----	----	----	----	----	----	----	----	----	----

Nombre _____ Fecha _____

1 Completa.

		D	U
40	cuarenta	4	0
41	cuarenta y uno	4	1
42			
43			
44			
45			
46			
47			
48			
49			

Nombre _____ Fecha _____

1 Completa.

		D	U
50	<i>cincuenta</i>	5	0
51	<i>cincuenta y uno</i>	5	1
52			
53			
54			
55			
56			
57			
58			
59			

Nombre _____ Fecha _____

1 Suma.

$20 + 30 = \square$

$50 + 30 = \square$

$40 + 40 = \square$

$20 + 40 = \square$

$30 + 30 = \square$

$30 + 10 = \square$

$50 + 20 = \square$

$60 + 30 = \square$

$30 + 40 = \square$

$70 + 20 = \square$

2 Resta.

$60 - 10 = \square$

$30 - 20 = \square$

$50 - 20 = \square$

$60 - 30 = \square$

$80 - 50 = \square$

$70 - 40 = \square$

$20 - 10 = \square$

$90 - 60 = \square$

$40 - 20 = \square$

$70 - 60 = \square$

Nombre _____ Fecha _____

1 Escribe $>$ o $<$.

$42 \bigcirc 18$

$39 \bigcirc 34$

$51 \bigcirc 48$

$52 \bigcirc 47$

$42 \bigcirc 53$

$15 \bigcirc 17$

$30 \bigcirc 25$

$39 \bigcirc 42$

$43 \bigcirc 34$

2 Ordena de menor a mayor.

43	44
47	49

$\square < \square < \square < \square$

46	48
56	50

$\square < \square < \square < \square$

3 Ordena de mayor a menor.

39	31
32	23

$\square > \square > \square > \square$

50	41
24	36

$\square > \square > \square > \square$

Nombre _____ Fecha _____

1 Suma.

$$\begin{array}{r} 15 \\ + 4 \\ \hline \square \end{array}$$

$$\begin{array}{r} 33 \\ + 5 \\ \hline \square \end{array}$$

$$\begin{array}{r} 12 \\ + 6 \\ \hline \square \end{array}$$

$$\begin{array}{r} 56 \\ + 3 \\ \hline \square \end{array}$$

$$\begin{array}{r} 14 \\ + 2 \\ \hline \square \end{array}$$

$$\begin{array}{r} 1 \\ + 28 \\ \hline \square \end{array}$$

$$\begin{array}{r} 4 \\ + 10 \\ \hline \square \end{array}$$

$$\begin{array}{r} 3 \\ + 44 \\ \hline \square \end{array}$$

$$\begin{array}{r} 6 \\ + 11 \\ \hline \square \end{array}$$

$$\begin{array}{r} 5 \\ + 52 \\ \hline \square \end{array}$$

$$\begin{array}{r} 21 \\ + 13 \\ \hline \square \end{array}$$

$$\begin{array}{r} 16 \\ + 43 \\ \hline \square \end{array}$$

$$\begin{array}{r} 34 \\ + 4 \\ \hline \square \end{array}$$

$$\begin{array}{r} 13 \\ + 32 \\ \hline \square \end{array}$$

$$\begin{array}{r} 25 \\ + 12 \\ \hline \square \end{array}$$

$$\begin{array}{r} 51 \\ + 4 \\ \hline \square \end{array}$$

$$\begin{array}{r} 22 \\ + 16 \\ \hline \square \end{array}$$

$$\begin{array}{r} 15 \\ + 11 \\ \hline \square \end{array}$$

$$\begin{array}{r} 28 \\ + 31 \\ \hline \square \end{array}$$

$$\begin{array}{r} 37 \\ + 2 \\ \hline \square \end{array}$$

$$\begin{array}{r} 11 \\ + 20 \\ \hline \square \end{array}$$

$$\begin{array}{r} 52 \\ + 6 \\ \hline \square \end{array}$$

$$\begin{array}{r} 40 \\ + 17 \\ \hline \square \end{array}$$

$$\begin{array}{r} 23 \\ + 3 \\ \hline \square \end{array}$$

$$\begin{array}{r} 17 \\ + 21 \\ \hline \square \end{array}$$

Nombre _____ Fecha _____

1 Completa.

	Decenas	Unidades		Decenas	Unidades	
56	→ 5	6		6	0	→ <input type="text"/>
40	→ <input type="text"/>	<input type="text"/>		1	1	→ <input type="text"/>
2	→ <input type="text"/>	<input type="text"/>		0	9	→ <input type="text"/>
28	→ <input type="text"/>	<input type="text"/>		5	9	→ <input type="text"/>
37	→ <input type="text"/>	<input type="text"/>		7	7	→ <input type="text"/>

2 Suma 2 cada vez.

<input type="text" value="2"/>	→ <input type="text"/>	→ <input type="text"/>	→ <input type="text"/>	→ <input type="text"/>	→ <input type="text"/>	→ <input type="text"/>	→ <input type="text"/>	→ <input type="text" value="18"/>
<input type="text" value="36"/>	← <input type="text"/>	← <input type="text"/>	← <input type="text"/>	← <input type="text"/>	← <input type="text"/>	← <input type="text"/>	← <input type="text"/>	← <input type="text" value="20"/>
<input type="text" value="38"/>	→ <input type="text"/>	→ <input type="text"/>	→ <input type="text"/>	→ <input type="text"/>	→ <input type="text"/>	→ <input type="text"/>	→ <input type="text"/>	→ <input type="text" value="54"/>
<input type="text" value="72"/>	← <input type="text"/>	← <input type="text"/>	← <input type="text"/>	← <input type="text"/>	← <input type="text"/>	← <input type="text"/>	← <input type="text"/>	← <input type="text" value="56"/>

3 Suma 2 cada vez.

<input type="text" value="1"/>	→ <input type="text" value="3"/>	→ <input type="text" value="5"/>	→ <input type="text"/>	→ <input type="text"/>	→ <input type="text"/>	→ <input type="text"/>	→ <input type="text"/>	→ <input type="text"/>
<input type="text" value="35"/>	← <input type="text"/>	← <input type="text"/>	← <input type="text"/>	← <input type="text"/>	← <input type="text"/>	← <input type="text"/>	← <input type="text"/>	← <input type="text" value="19"/>
<input type="text" value="37"/>	→ <input type="text"/>	→ <input type="text"/>	→ <input type="text"/>	→ <input type="text"/>	→ <input type="text"/>	→ <input type="text"/>	→ <input type="text"/>	→ <input type="text"/>

Nombre _____ Fecha _____

1 Completa.

		D	U
70	setenta	7	0
71			
72			
73			
74			
75			
76			
77			
78			
79			

Nombre _____ Fecha _____

1 Completa.

		D	U
80	ochenta	8	0
81			
82			
83			
84			
85			
86			
87			
88			
89			

Nombre _____ Fecha _____

1 Suma 3 cada vez.

3 → □ → □ → □ → □ → 18 → □ → □

□ ← □ ← 42 ← □ ← □ ← □ ← □ ← □

□ → □ → □ → 60 → □ → □ → □ → □

□ ← □ ← □ ← □ ← □ ← □ ← □ ← 78 ← □

2 Resta 2 cada vez.

98 → 96 → □ → □ → □ → □ → □ → □

□ ← □ ← □ ← □ ← □ ← □ ← □ ← □

66 → □ → □ → □ → □ → □ → □ → □

36 ← □ ← □ ← □ ← □ ← □ ← □ ← □

□ → □ → □ → □ → □ → □ → □ → □

□ ← □ ← □ ← □ ← □ ← □ ← 14 ← □ ← □

□ → 0

Nombre _____ Fecha _____

1 Resta.

$\begin{array}{r} 49 \\ - 3 \\ \hline \square \end{array}$	$\begin{array}{r} 55 \\ - 34 \\ \hline \square \end{array}$	$\begin{array}{r} 75 \\ - 14 \\ \hline \square \end{array}$	$\begin{array}{r} 59 \\ - 5 \\ \hline \square \end{array}$	$\begin{array}{r} 88 \\ - 23 \\ \hline \square \end{array}$
--	---	---	--	---

$\begin{array}{r} 47 \\ - 23 \\ \hline \square \end{array}$	$\begin{array}{r} 55 \\ - 31 \\ \hline \square \end{array}$	$\begin{array}{r} 93 \\ - 30 \\ \hline \square \end{array}$	$\begin{array}{r} 37 \\ - 26 \\ \hline \square \end{array}$	$\begin{array}{r} 23 \\ - 12 \\ \hline \square \end{array}$
---	---	---	---	---

$\begin{array}{r} 35 \\ - 15 \\ \hline \square \end{array}$	$\begin{array}{r} 88 \\ - 26 \\ \hline \square \end{array}$	$\begin{array}{r} 57 \\ - 45 \\ \hline \square \end{array}$	$\begin{array}{r} 47 \\ - 2 \\ \hline \square \end{array}$	$\begin{array}{r} 79 \\ - 33 \\ \hline \square \end{array}$
---	---	---	--	---

$\begin{array}{r} 57 \\ - 40 \\ \hline \square \end{array}$	$\begin{array}{r} 98 \\ - 50 \\ \hline \square \end{array}$	$\begin{array}{r} 17 \\ - 15 \\ \hline \square \end{array}$	$\begin{array}{r} 88 \\ - 7 \\ \hline \square \end{array}$	$\begin{array}{r} 44 \\ - 23 \\ \hline \square \end{array}$
---	---	---	--	---

$\begin{array}{r} 52 \\ - 41 \\ \hline \square \end{array}$	$\begin{array}{r} 24 \\ - 12 \\ \hline \square \end{array}$	$\begin{array}{r} 96 \\ - 25 \\ \hline \square \end{array}$	$\begin{array}{r} 36 \\ - 10 \\ \hline \square \end{array}$	$\begin{array}{r} 83 \\ - 21 \\ \hline \square \end{array}$
---	---	---	---	---

Nombre _____ Fecha _____

1 Completa.

		D	U
90	noventa	9	0
91			
92			
93			
94			
95			
96			
97			
98			
99			

Nombre _____ Fecha _____

1 Completa.

		D	U
15	quince	1	5
20			
21			
26			
28			
35			
40			
61			
76			
88			

Nombre _____ Fecha _____

1 Calcula.

$$\begin{array}{r} 30 \\ + 13 \\ \hline \square \end{array}$$

$$\begin{array}{r} 52 \\ + 34 \\ \hline \square \end{array}$$

$$\begin{array}{r} 64 \\ + 25 \\ \hline \square \end{array}$$

$$\begin{array}{r} 41 \\ + 33 \\ \hline \square \end{array}$$

$$\begin{array}{r} 72 \\ + 7 \\ \hline \square \end{array}$$

$$\begin{array}{r} 53 \\ - 21 \\ \hline \square \end{array}$$

$$\begin{array}{r} 89 \\ - 6 \\ \hline \square \end{array}$$

$$\begin{array}{r} 58 \\ - 16 \\ \hline \square \end{array}$$

$$\begin{array}{r} 75 \\ - 73 \\ \hline \square \end{array}$$

$$\begin{array}{r} 82 \\ - 61 \\ \hline \square \end{array}$$

$$\begin{array}{r} 95 \\ - 52 \\ \hline \square \end{array}$$

$$\begin{array}{r} 64 \\ - 62 \\ \hline \square \end{array}$$

$$\begin{array}{r} 42 \\ + 47 \\ \hline \square \end{array}$$

$$\begin{array}{r} 40 \\ - 10 \\ \hline \square \end{array}$$

$$\begin{array}{r} 43 \\ + 56 \\ \hline \square \end{array}$$

$$\begin{array}{r} 66 \\ + 30 \\ \hline \square \end{array}$$

$$\begin{array}{r} 49 \\ - 21 \\ \hline \square \end{array}$$

$$\begin{array}{r} 73 \\ + 4 \\ \hline \square \end{array}$$

$$\begin{array}{r} 60 \\ + 20 \\ \hline \square \end{array}$$

$$\begin{array}{r} 79 \\ - 64 \\ \hline \square \end{array}$$

$$\begin{array}{r} 90 \\ - 70 \\ \hline \square \end{array}$$

$$\begin{array}{r} 52 \\ + 27 \\ \hline \square \end{array}$$

$$\begin{array}{r} 97 \\ - 62 \\ \hline \square \end{array}$$

$$\begin{array}{r} 23 \\ + 45 \\ \hline \square \end{array}$$

$$\begin{array}{r} 89 \\ - 32 \\ \hline \square \end{array}$$

Nombre _____ Fecha _____

1 Suma.

$\begin{array}{r} 33 \\ 12 \\ + 4 \\ \hline \square \end{array}$	$\begin{array}{r} 16 \\ 40 \\ + 2 \\ \hline \square \end{array}$	$\begin{array}{r} 62 \\ 6 \\ + 11 \\ \hline \square \end{array}$	$\begin{array}{r} 5 \\ 21 \\ + 70 \\ \hline \square \end{array}$	$\begin{array}{r} 24 \\ 12 \\ + 3 \\ \hline \square \end{array}$
--	--	--	--	--

$\begin{array}{r} 24 \\ 13 \\ + 51 \\ \hline \square \end{array}$	$\begin{array}{r} 65 \\ 11 \\ + 21 \\ \hline \square \end{array}$	$\begin{array}{r} 13 \\ 41 \\ + 31 \\ \hline \square \end{array}$	$\begin{array}{r} 6 \\ 52 \\ + 20 \\ \hline \square \end{array}$	$\begin{array}{r} 22 \\ 32 \\ + 42 \\ \hline \square \end{array}$
---	---	---	--	---

$\begin{array}{r} 32 \\ 42 \\ + 24 \\ \hline \square \end{array}$	$\begin{array}{r} 43 \\ 13 \\ + 23 \\ \hline \square \end{array}$	$\begin{array}{r} 32 \\ 61 \\ + 5 \\ \hline \square \end{array}$	$\begin{array}{r} 24 \\ 21 \\ + 42 \\ \hline \square \end{array}$	$\begin{array}{r} 24 \\ 30 \\ + 41 \\ \hline \square \end{array}$
---	---	--	---	---

$\begin{array}{r} 52 \\ 15 \\ + 22 \\ \hline \square \end{array}$	$\begin{array}{r} 70 \\ 10 \\ + 19 \\ \hline \square \end{array}$	$\begin{array}{r} 12 \\ 20 \\ + 13 \\ \hline \square \end{array}$	$\begin{array}{r} 83 \\ 2 \\ + 12 \\ \hline \square \end{array}$	$\begin{array}{r} 27 \\ 11 \\ + 60 \\ \hline \square \end{array}$
---	---	---	--	---

Nombre _____ Fecha _____

1 Suma.

$$\begin{array}{r} 58 \\ + 9 \\ \hline \square \end{array}$$

$$\begin{array}{r} 32 \\ + 9 \\ \hline \square \end{array}$$

$$\begin{array}{r} 26 \\ + 7 \\ \hline \square \end{array}$$

$$\begin{array}{r} 29 \\ + 6 \\ \hline \square \end{array}$$

$$\begin{array}{r} 38 \\ + 5 \\ \hline \square \end{array}$$

$$\begin{array}{r} 25 \\ + 5 \\ \hline \square \end{array}$$

$$\begin{array}{r} 43 \\ + 19 \\ \hline \square \end{array}$$

$$\begin{array}{r} 26 \\ + 25 \\ \hline \square \end{array}$$

$$\begin{array}{r} 47 \\ + 5 \\ \hline \square \end{array}$$

$$\begin{array}{r} 55 \\ + 16 \\ \hline \square \end{array}$$

$$\begin{array}{r} 29 \\ + 11 \\ \hline \square \end{array}$$

$$\begin{array}{r} 74 \\ + 18 \\ \hline \square \end{array}$$

$$\begin{array}{r} 28 \\ + 25 \\ \hline \square \end{array}$$

$$\begin{array}{r} 39 \\ + 25 \\ \hline \square \end{array}$$

$$\begin{array}{r} 46 \\ + 16 \\ \hline \square \end{array}$$

$$\begin{array}{r} 67 \\ + 29 \\ \hline \square \end{array}$$

$$\begin{array}{r} 38 \\ + 38 \\ \hline \square \end{array}$$

$$\begin{array}{r} 49 \\ + 32 \\ \hline \square \end{array}$$

$$\begin{array}{r} 42 \\ + 39 \\ \hline \square \end{array}$$

$$\begin{array}{r} 57 \\ + 38 \\ \hline \square \end{array}$$

$$\begin{array}{r} 36 \\ + 48 \\ \hline \square \end{array}$$

$$\begin{array}{r} 24 \\ + 57 \\ \hline \square \end{array}$$

$$\begin{array}{r} 38 \\ + 39 \\ \hline \square \end{array}$$

$$\begin{array}{r} 24 \\ + 46 \\ \hline \square \end{array}$$

$$\begin{array}{r} 19 \\ + 41 \\ \hline \square \end{array}$$

Nombre _____ Fecha _____

1 Suma.

$\begin{array}{r} 26 \\ 5 \\ + 4 \\ \hline \square \end{array}$	$\begin{array}{r} 38 \\ 7 \\ + 2 \\ \hline \square \end{array}$	$\begin{array}{r} 42 \\ 6 \\ + 5 \\ \hline \square \end{array}$	$\begin{array}{r} 52 \\ 9 \\ + 5 \\ \hline \square \end{array}$	$\begin{array}{r} 54 \\ 7 \\ + 3 \\ \hline \square \end{array}$
---	---	---	---	---

$\begin{array}{r} 16 \\ 15 \\ + 4 \\ \hline \square \end{array}$	$\begin{array}{r} 24 \\ 26 \\ + 6 \\ \hline \square \end{array}$	$\begin{array}{r} 23 \\ 12 \\ + 8 \\ \hline \square \end{array}$	$\begin{array}{r} 22 \\ 27 \\ + 5 \\ \hline \square \end{array}$	$\begin{array}{r} 44 \\ 21 \\ + 8 \\ \hline \square \end{array}$
--	--	--	--	--

$\begin{array}{r} 25 \\ 13 \\ + 16 \\ \hline \square \end{array}$	$\begin{array}{r} 8 \\ 50 \\ + 27 \\ \hline \square \end{array}$	$\begin{array}{r} 2 \\ 37 \\ + 49 \\ \hline \square \end{array}$	$\begin{array}{r} 58 \\ 23 \\ + 14 \\ \hline \square \end{array}$	$\begin{array}{r} 29 \\ 11 \\ + 23 \\ \hline \square \end{array}$
---	--	--	---	---

$\begin{array}{r} 54 \\ 20 \\ + 16 \\ \hline \square \end{array}$	$\begin{array}{r} 37 \\ 13 \\ + 20 \\ \hline \square \end{array}$	$\begin{array}{r} 31 \\ 19 \\ + 10 \\ \hline \square \end{array}$	$\begin{array}{r} 32 \\ 16 \\ + 14 \\ \hline \square \end{array}$	$\begin{array}{r} 14 \\ 14 \\ + 28 \\ \hline \square \end{array}$
---	---	---	---	---

Solucionario

Ficha 1

1 Rodear: 5-2-8-4-3-7

2 3, 4, 5, 6, 7, 8
6, 5, 4, 3, 2, 1

Ficha 2

1 $4 + 5 = 9$
 $6 + 3 = 9$
 $3 + 6 = 9$
 $8 + 1 = 9$
 $7 + 2 = 9$
 $3 + 3 = 6$
 $2 + 4 = 6$
 $4 + 2 = 6$
 $1 + 5 = 6$
 $5 + 1 = 6$

Ficha 3

1 $2 + 1 = 3$
 $4 + 3 = 7$
 $7 + 2 = 9$
 $4 + 2 = 6$

2 $3 + 2 = 5$
 $3 + 3 = 6$
 $4 + 2 = 6$
 $6 + 2 = 8$

Ficha 4

1 3, 5, 7, 9
2, 4, 6, 8

2 4, 7
3, 6, 9

3 1, 2, 3, 4, 5
5, 4, 3, 2, 1

5, 6, 7, 8, 9
9, 8, 7, 6, 5

Ficha 5

1 $10 + 3 = 13$
 $10 + 6 = 16$
 $10 + 4 = 14$
 $10 + 7 = 17$
 $10 + 9 = 19$
 $10 + 5 = 15$
 $10 + 1 = 11$
 $10 + 8 = 18$

Ficha 6

1 $5 - 3 = 2$
 $7 - 4 = 3$
 $9 - 2 = 7$
 $8 - 6 = 2$
 $6 - 3 = 3$
 $9 - 5 = 4$
 $5 - 3 = 2$
 $4 - 2 = 2$

Ficha 7

1 9, 8, 7, 5, 9, 3
10, 7, 8, 10, 8, 9
6, 6, 10, 5, 7, 10

2 5, 6, 8, 10
3, 6, 8, 10

Ficha 8

1 Cero, uno, dos, tres, cuatro,
cinco, seis, siete, ocho,
nueve, diez, once, doce,
trece, catorce, quince,
dieciséis, diecisiete,
dieciocho, diecinueve.

2 quince \rightarrow 15
ocho \rightarrow 8
once \rightarrow 11
dieciséis \rightarrow 16

Ficha 9

1 0, 1, 2, 3, 4, 5, 6, 7, 8, 9,
10, 11, 12, 13, 14, 15, 16,
17, 18, 19

2 4, 6, 8, 10, 12, 14, 16, 18
3, 5, 7, 9, 11, 13, 15, 17, 19

Ficha 10

1 19, 14, 15, 16, 12, 18, 16, 15
10, 17, 19, 18, 19, 14, 19, 13
11, 19, 10, 18, 11, 18, 17, 17

2 6, 9, 12, 15, 18

Ficha 11

1 Diez, veinte, treinta,
cuarenta, cincuenta,
sesenta, setenta, ochenta,
noventa.

2 30, 40, 50, 60, 70, 80, 90

3 veinte \rightarrow 20
cuarenta \rightarrow 40
sesenta \rightarrow 60
setenta \rightarrow 70

Ficha 12

1 2, 2, 1, 5, 3, 5, 3, 1, 3

Solucionario

Ficha 13

- 1** $6 + 2 = 8$
 $8 + 3 = 11$
 $8 + 4 = 12$
 $6 + 5 = 11$
 $15 + 4 = 19$
 $10 + 4 = 14$

- 2** 9, 9, 10
 10, 11, 17

Ficha 14

- 1** 3, 5, 7, 9, 11, 13, 15, 17, 19,
 21, 23, 25, 27, 29

- 2** 26, 23, 20, 17, 14, 11, 8,
 5, 2

- 3** 17, 23, 28, 14
 Decenas: 2, 1, 2, 2
 Unidades: 6, 2, 1, 0

Ficha 15

- 1** 36, 33, 30, 27, 24, 21, 18,
 15, 12, 9, 6, 3

- 2** 3, 6, 8, 11, 13, 16, 18, 21,
 23, 26, 28, 31, 33, 36

- 3** 10-20-29
 20-30-30

Ficha 16

- 1** 9, 6, 5, 7, 4, 7

Ficha 17

		D	U
40	cuarenta	4	0
41	cuarenta y uno	4	1
42	cuarenta y dos	4	2
43	cuarenta y tres	4	3
44	cuarenta y cuatro	4	4
45	cuarenta y cinco	4	5
46	cuarenta y seis	4	6
47	cuarenta y siete	4	7
48	cuarenta y ocho	4	8
49	cuarenta y nueve	4	9

Ficha 18

		D	U
50	cincuenta	5	0
51	cincuenta y uno	5	1
52	cincuenta y dos	5	2
53	cincuenta y tres	5	3
54	cincuenta y cuatro	5	4
55	cincuenta y cinco	5	5
56	cincuenta y seis	5	6
57	cincuenta y siete	5	7
58	cincuenta y ocho	5	8
59	cincuenta y nueve	5	9

Ficha 19

- 1** 50, 80, 80, 60, 60
 40, 70, 90, 70, 90
- 2** 50, 10, 30, 30, 30
 30, 10, 30, 20, 10

Ficha 20

- 1** $42 > 18$, $39 > 34$, $51 > 48$
 $52 > 47$, $42 < 53$, $15 < 17$
 $30 > 25$, $39 < 42$, $43 > 34$

- 2** $43 < 44 < 47 < 49$
 $46 < 48 < 50 < 56$

- 3** $39 > 32 > 31 > 23$
 $50 > 41 > 36 > 24$

Ficha 21

- 1** 19, 38, 18, 59, 16
 29, 14, 47, 17, 57
 34, 59, 38, 45, 37
 55, 38, 26, 59, 39
 31, 58, 57, 26, 38

Ficha 22

- 1** Decenas: 5, 4, 0, 2, 3
 Unidades: 6, 0, 2, 8, 7
 60, 11, 9, 59, 77

- 2** 4, 6, 8, 10, 12, 14, 16, 18,
 20, 22, 24, 26, 28, 30, 32,
 34, 36, 38, 40, 42, 44, 46,
 48, 50, 52, 54, 56, 58, 60,
 62, 64, 66, 68, 70, 72

- 3** 7, 9, 11, 13, 15, 17, 19, 21,
 23, 25, 27, 29, 31, 33, 35,
 37, 39, 41, 43, 45, 47, 49, 51,
 53

Ficha 23

		D	U
70	setenta	7	0
71	setenta y uno	7	1
72	setenta y dos	7	2
73	setenta y tres	7	3
74	setenta y cuatro	7	4
75	setenta y cinco	7	5
76	setenta y seis	7	6
77	setenta y siete	7	7
78	setenta y ocho	7	8
79	setenta y nueve	7	9

Solucionario

Ficha 24

1		D	U
80	ochenta	8	0
81	ochenta y uno	8	1
82	ochenta y dos	8	2
83	ochenta y tres	8	3
84	ochenta y cuatro	8	4
85	ochenta y cinco	8	5
86	ochenta y seis	8	6
87	ochenta y siete	8	7
88	ochenta y ocho	8	8
89	ochenta y nueve	8	9

Ficha 25

1 6, 9, 12, 15, 18, 21, 24, 27, 30, 33, 36, 39, 42, 45, 48, 51, 54, 57, 60, 63, 66, 69, 72, 75, 78, 81, 84, 87, 90, 93, 96

2 96, 94, 92, 90, 88, 86, 84, 82, 80, 78, 76, 74, 72, 70, 68, 66, 64, 62, 60, 58, 56, 54, 52, 50, 48, 46, 44, 42, 40, 38, 36, 34, 32, 30, 28, 26, 24, 22, 20, 18, 16, 14, 12, 10, 8, 6, 4, 2, 0

Ficha 26

1 46, 21, 61, 54, 65
24, 24, 63, 11, 11
20, 62, 12, 45, 46
17, 48, 02, 81, 21
11, 12, 71, 26, 62

Ficha 27

1		D	U
90	noventa	9	0
91	noventa y uno	9	1
92	noventa y dos	9	2
93	noventa y tres	9	3
94	noventa y cuatro	9	4
95	noventa y cinco	9	5
96	noventa y seis	9	6
97	noventa y siete	9	7
98	noventa y ocho	9	8
99	noventa y nueve	9	9

Ficha 28

1		D	U
15	quince	1	5
20	veinte	2	0
21	veintiuno	2	1
26	veintiséis	2	6
28	veintiocho	2	8
35	treinta y cinco	3	5
40	cuarenta	4	0
61	sesenta y uno	6	1
76	setenta y seis	7	6
88	ochenta y ocho	8	8

Ficha 29

1 43, 86, 89, 74, 79
32, 83, 42, 2, 21
43, 2, 89, 30, 99
96, 28, 77, 80, 15
20, 79, 35, 68, 57

Ficha 30

1 49, 58, 79, 96, 39
88, 97, 85, 78, 96
98, 79, 98, 87, 95
89, 99, 45, 97, 98

Ficha 31

1 67, 41, 33, 35, 43
30, 62, 51, 52, 71
40, 92, 53, 64, 62
96, 76, 81, 81, 95
84, 81, 77, 70, 60

Ficha 32

1 35, 47, 53, 66, 64
35, 56, 43, 54, 73
54, 85, 88, 95, 63
90, 70, 60, 62, 56



Números a la carta