

INORGANIC AND APPLIED CHEMISTRY

PETER DYBDAHL HEDE & SØREN PRIP BEIER



**FREE STUDY BOOKS
WWW.BOOKBOON.COM**

Peter Dybdahl Hede & Søren Prip Beier

Inorganic and Applied Chemistry

Inorganic and Applied Chemistry

© 2007 Peter Dybdahl Hede, Søren Prip Beier & Ventus Publishing Aps

ISBN 978-87-7681-221-9

Contents

Preface	11
1. Atoms	12
1.1 Atomic nucleus, electrons and orbitals	12
1.1.1 Components of the atom	12
1.1.2 Electron movement and electromagnetic radiation	15
1.1.3 Bohr's atomic model	17
1.1.4 Photons	18
1.1.5 Radioactive decay	21
1.1.6 Wave functions and orbitals	24
1.1.7 Orbital configuration	25
1.2 Construction of the periodic table	28
1.2.1 Aufbau principle	28
1.2.2 Electron configuration	29
1.2.3 Categorization of the elements	36
1.2.4 Periodic tendencies	39
1.3 Summing up on chapter 1	45
2. Chemical compounds	46
2.1 Bonds and forces	46
2.1.1 Bond types	46
2.1.2 Intermolecular forces	47
2.2 Covalent bonds	52
2.2.1 Energy considerations	52
2.2.2 Molecular orbital theory	53
2.2.3 Lewis structure	58

Please click the advert

WHAT'S MISSING IN THIS EQUATION?

You could be one of our future talents

MAERSK INTERNATIONAL TECHNOLOGY & SCIENCE PROGRAMME

Are you about to graduate as an **engineer** or **geoscientist**? Or have you already graduated?
If so, there may be an exciting future for you with A.P. Moller - Maersk.



MAERSK

www.maersk.com/mitas

2.2.4	VSEPR theory	66
2.2.5	Orbital hybridization	70
2.3	Metallic bonds	77
2.3.1	Band theory	78
2.3.2	Lattice structures	79
2.4	Ionic bonds	86
2.4.1	Ionic character	87
2.4.2	Lattice structures for ionic compounds	88
2.4.3	Energy calculations in ionic compounds	92
2.5	Summing up on chapter 2	94
3.	Reactions kinetics	96
3.1	The chemical reaction	96
3.2	Rate of reaction	97
3.3	Rate expressions	99
3.4	Chemical kinetics and catalysts	101
3.5	Kinetics of radioactive decay	103
3.5.1	Half-life	104
3.6	Summing up on chapter 3	107
4.	Equilibrium	108
4.1	Solubility equilibrium and solubility product	108
4.1.1	Relative solubility	109
4.1.2	Ion effects on solubility	112
4.2	Precipitation	114
4.2.1	Selective precipitation	117
4.3	Summing up on chapter 4	118

www.job.oticon.dk

oticon
PEOPLE FIRST

5.	Acids and bases	119
5.1	About acids and bases	119
5.1.1	Acid strength	119
5.1.2	The pH-scale	120
5.1.3	The autoprotolysis of water	122
5.2	pH calculations	122
5.2.1	Calculation of pH in strong acid solutions	122
5.2.2	Calculation of pH in weak acid solutions	123
5.2.3	Calculation of pH in mixtures of weak acids	125
5.3	Polyprotic acids	127
5.4	Acid properties of salts	129
5.4	Ion effects on pH	131
5.5	Buffer	133
5.5.1	The Buffer equation	133
5.5.1	Buffer capacity	137
5.6	Titrations and pH curves	138
5.6.1	Titration of polyprotic acids	144
5.6.2	Colour indicators for acid/base titration	147
5.7	Summing up on chapter 5	149
6.	Electrochemistry	150
6.1	Oxidation and reduction	150
6.1.1	Level of oxidation	151
6.1.2	Methods for balancing redox reactions	153
6.2	Galvanic cells	158
6.2.2	Cell potentials	160
6.3	Standard reduction potentials	160
6.4	Concentration dependency of cell potentials	165
6.5	Batteries	169

Please click the advert

CHALLENGE YOURSELF

WWW.STUDYINSWEDEN.SE

Today's job market values ambitious, innovative, perceptive team players. Swedish universities foster these qualities through a forward-thinking culture where you're close to the latest ideas and global trends.

Si.
Swedish Institute

Whatever your career goals may be, studying in Sweden will give you valuable skills and a competitive advantage for your future. www.studyinsweden.se

6.6	Corrosion	175
6.7	Electrolysis	178
6.8	Summing up on chapter 6	181
7.	Concluding remarks	182

Please click the advert

Always aiming for higher ground. Just another day at the office for a Tiger.

Join the Accenture High Performance Business Forum

On Thursday, April 23rd, Accenture invites top students to the High Performance Business Forum where you can learn how leading Danish companies are using the current economic downturn to gain competitive advantages. You will meet two of Accenture's global senior executives as they present new original research and illustrate how technology can help forward thinking companies cope with the downturn.

Visit student.accentureforum.dk to see the program and register

Visit student.accentureforum.dk

• Consulting • Technology • Outsourcing

accenture
High performance. Delivered.

© 2009 Accenture. All rights reserved.

List of examples

Example 1-A: Two isotopes of uranium	13
Example 1- B: Oxidation states for single ions and composite ions	14
Example 1- C: Energy of a photon	19
Example 1- D: Mass and energy (Einstein equation)	20
Example 1- E: Emission of alpha and gamma radiation	22
Example 1- F: Emission of beta radiation	23
Example 1- G: Decay chain	23
Example 1- H: Quantum numbers and designations for different orbitals	27
Example 1- I: Filling of electrons in the 1 st period	30
Example 1- J: Filling of electrons in the 2 nd period	31
Example 1- K: Filling of electrons in the 3 rd period	33
Example 1- L: Filling of electrons in the 4 th period	34
Example 1- M: Filling of electrons in the 5 th period	35
Example 1- N: Filling of electrons in the 6 th and 7 th period	36
Example 1- O: Oxidation state (transition metal and main group element)	38
Example 1- P: Atomic radius	40
Example 1- Q: Ionization energy	42
Example 1- R: Electronegativity	44
Example 2- A: Dipole-dipole forces among HCl molecules	49
Example 2- B: Hydrogen bonds between water molecules	50
Example 2- C: London forces between hydrogen molecules	51
Example 2- D: Molecular orbitals in the hydrogen molecule	54
Example 2- E: Molecular orbitals in a “helium molecule”	56
Example 2- F: Atoms in “dot notation”	59
Example 2- G: The ammonia molecule in Lewis structure	60

Example 2- H: The carbon dioxide molecule in Lewis structure	61
Example 2- I: The sulphur hexafluoride molecule in Lewis structure	62
Example 2- J: Nitrat in Lewis structure	63
Example 2- K: The dinitrogen oxid molecule in Lewis structure	65
Example 2- L: CO ₂ and H ₂ O, VSEPR theory	68
Example 2- M: NH ₃ molecule, <i>sp</i> ³ -hybridization	72
Example 2- N: C ₂ H ₄ molecule, <i>sp</i> ² -hybridization	74
Example 2- O: CO ₂ molecule, <i>sp</i> -hybridization	75
Example 2- P: Density of tungsten (W)	85
Example 2- Q: Atomic radius for ruthenium (Ru)	86
Example 2- R: Energy calculations for lithium fluoride (LiF)	93
Example 3- A: Reaction equation for precipitation of BaSO ₄	96
Example 3- B: Production of ammonia	97
Example 3- C: Decomposition of nitrogen dioxid	98
Example 3- D: Order of reaction and rate expressions	100
Example 3- E: Energy of activation	102
Example 3- F: Enzymes – catalysts of nature	103
Example 3- G: Radon in the cellar!	105
Example 3- H: Carbon-14 as a method to determine age	106
Example 4- A: Calculation of solubility of PbSO ₄	109
Example 4- B: Relative solubility; first example	110
Example 4- C: Relative solubility; second example	111
Example 4- D: Solubility and foreign ions	113
Example 4- E: Equilibrium concentration after precipitation of lead nitrate (PbNO ₃)	115
Example 4- F: Selective precipitation	117

Example 5- A:	pH calculation in a strong acid (hydrochloric acid)	123
Example 5- B:	pH calculation in weak acid solution	124
Example 5- C:	pH in the solution with two weak acids	126
Example 5- D:	pH in a solution of polyprotic acid	128
Example 5- E:	pH in a solution of aluminium chloride	130
Example 5- F:	pH in a solution of foreign ions	132
Example 5- G:	pH in a buffer solution	134
Example 5- H:	Buffer capacity	136
Example 5- I:	Titration of weak acid with strong base	139
Example 5- J:	Titration of a divalent acid	145
Example 6- A:	Assigning levels of oxidation	152
Example 6- B:	The method of half-reaction in acid aqueous solution	154
Example 6- C:	The method of half-reaction in basic aqueous solution	156
Example 6- D:	Half-cell potentials	161
Example 6- E:	Calculation of cell potential and spontaneity	164
Example 6- F:	The use of the Nernst equation to determine the cell potential	166
Example 6- G:	The use of the Nernst equation to calculate equilibrium constants	168
Example 6- H:	Lead battery	170
Example 6- I:	Dry cell batteries	172
Example 6- J:	Fuel cells	174
Example 6- K:	Aluminium oxide as protection against corrosion	176
Example 6- L:	Aluminium oxide as protection against corrosion	177
Example 6- M:	Electrolysis of water	181

Please click the advert



it's an interesting world

Get under the skin of it.

Graduate opportunities Cheltenham | £24,945 + benefits

One of the UK's intelligence services, GCHQ's role is two-fold: to gather and analyse intelligence which helps shape Britain's response to global events, and, to provide technical advice for the protection of Government communication and information systems. In doing so, our specialists – in IT, internet, engineering, languages, information assurance, mathematics and intelligence – get well beneath the surface of global affairs. If you thought the world was an interesting place, you really ought to explore our world of work.

www.careersinbritishintelligence.co.uk

Applicants must be British citizens. GCHQ values diversity and welcomes applicants from all sections of the community. We want our workforce to reflect the diversity of our work.



Preface

This book is written primarily to engineering students in the fields of basic chemistry, environmental chemistry, food production, chemical and biochemical engineering who in the beginning of their university studies receive education in inorganic chemistry and applied chemistry in general.

The aim of this book is to explain and clarify important terms and concepts which the students are supposed to have knowledge about. This book can not replace existing educational textbooks about inorganic basic chemistry and general applied chemistry, but it gives a great supplement to the education. Many smaller assignments and examples including solutions are given in the book.

The book is divided into six main sections covering the introductory parts of the general chemical education at universities and chemical engineering schools. One of the aims of this book is to lighten the shift over from grammar school/high school/gymnasium to the university.

We alone are responsible for any misprints or errors and we will be grateful to receive any critics and suggestions for improvement.

Chapter 1 }
Chapter 2 } Søren Prip Beier

Copenhagen, November 2006

Chapter 3 }
Chapter 4 }
Chapter 5 } Peter Dybdahl Hede
Chapter 6 }

Peter Dybdahl Hede og Søren Prip Beier

1. Atoms

The aim of this chapter is to introduce concepts and theory that is necessary to have knowledge about in order to get a general introduction into the field of chemistry and to get an understanding of many fundamental aspects concerning chemistry. Initially we are going to look at the single atom itself and then we move to the arrangement of the elements into the periodic table.

1.1 Atomic nucleus, electrons and orbitals

The topic of this first chapter is the single atom itself. All matter is composed of atoms and to get a general understanding of the composition of atoms and their nature we first have to learn about electromagnetic radiation. Electromagnetic radiation is closely related to the nature of atoms and especially to the positions and movements of the electrons relative to the atomic nuclei.

1.1.1 Components of the atom

An atom is composed of a *nucleus* surrounded by *electrons*. The nucleus consists of positively charged *protons* and uncharged *neutrons*. The charge of an electron is -1 and the charge of a proton is $+1$. An atom in its ground state is neutral (uncharged) because it consists of an equal amount of protons and electrons. The number of neutrons in the nucleus of an element can however vary resulting in more than one *isotope*. Hydrogen for example has three isotopes:

- Hydrogen, H, Nucleus composition : 1 proton + 0 neutrons
 - Deuterium, D, Nucleus composition : 1 proton + 1 neutron
 - Tritium, T, Nucleus composition : 1 proton + 2 neutrons
- } the 3 isotopes of hydrogen

The three isotopes of hydrogen each have its own chemical symbol (H, D and T) whereas isotopes of other elements do not have special chemical symbols. Many elements have many isotopes but only relatively few of these are stable. A stable isotope will not undergo radioactive decay. The nucleus of an unstable isotope on the other hand will undergo radioactive decay which means that the nucleus will transform into other isotopes or even other elements. In the following example we will look more at isotopes for the element uranium.

Example 1- A:*Two isotopes of uranium*

A classical example of an element with unstable isotopes is uranium. Uranium-235 is a uranium isotope in which the nucleus consists of 92 protons and 143 neutrons ($92 + 143 = 235$). *Nucleons* are a common designation for both protons and neutrons since they are both positioned in the nucleus. Uranium-238 is another uranium isotope in which the nucleus consists of 92 protons and 146 neutrons (total number of nucleons = $92 + 146 = 238$). These two uranium isotopes can be written as follows:

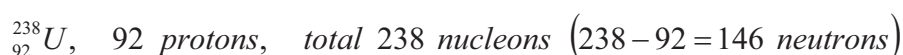

It is seen that the two isotopes do not have special chemical symbols. They both use the “U” for *uranium* followed by the number of total amount of nucleons which in this case is 235 and 238 respectively.

The nucleus constitutes only a very small part of the total volume of the atom. If an atom is compared with an orange (100 mm in diameter) the nucleus will be placed in the centre with a diameter of only 0.001 mm.

Please click the advert



CHALLENGE YOURSELF

WWW.STUDYINSWEDEN.SE

Today's job market values ambitious, innovative, perceptive team players. Swedish universities foster these qualities through a forward-thinking culture where you're close to the latest ideas and global trends.

Si.
Swedish Institute

Whatever your career goals may be, studying in Sweden will give you valuable skills and a competitive advantage for your future. www.studyinsweden.se

Download free books at BookBoon.com

The weight of a proton and a neutron is approximately the same ($1.67 \cdot 10^{-27}$ kg) whereas the weight of an electron is only 0.05% of this weight ($9.11 \cdot 10^{-31}$ kg). If an atom lets off or receives electrons it becomes an *ion*. An ion is either positively or negatively charged. If an atom lets off one or more electrons the overall charge will become positive and you then have a so-called *cation*. If an atom receives one or more electrons the overall charge will be negative and you then have a so-called *anion*.

When electrons are let off or received the *oxidation state* of the atom is changed. We will look more into oxidation states in the following example.

Example 1- B:

Oxidation states for single ions and composite ions

When magnesium and chlorine reacts, the magnesium atom lets off electrons to chlorine and thus the oxidation states are changed:



One sees that the oxidation state equals the charge of the ion. The cations are normally named just by adding "ion" after the name of the element (Mg^{+} = magnesium ion) whereas the suffix "-id" replaces the suffix of the element for anions (Cl^{-} = chloride). For composite ions, a shared (total) oxidation number is used. This shared oxidation state is the sum of all the oxidation states for the different ions in the composite ion. Uncharged atoms have the oxidation number of zero. The ammonium ion and hydroxide are both examples of composite ions:



The oxidation state for hydride is always "+1" (H^{+}) and the oxidation state for oxide is always "-2" (O^{2-}). However there are exceptions. For example the oxidation state of oxygen in hydrogen peroxide (H_2O_2) is "-1" and in lithium hydride (LiH) the oxidation state of hydrogen is "-1".

1.1.2 Electron movement and electromagnetic radiation

Description of the position of the electron relative to the atomic nucleus is closely related to emission or absorption of electromagnetic radiation. Therefore we are going to look a bit more into this topic. Energy can be transported by electromagnetic radiation as waves. The wavelength can vary from 10^{-12} meter (gamma radiation) to 10^4 meter (AM radio waves). Visible light is also electromagnetic radiation with wavelengths varying from $4 \cdot 10^{-7}$ meter (purple light) to $7 \cdot 10^{-7}$ meter (red light). Thus visible light only comprises a very small part of the electromagnetic spectrum.

Light with different wavelengths have different colours. White light consists of light with all wavelengths in the visible spectrum. The relationship between wavelength and frequency is given by the following equation:

$$c = \lambda \cdot f, \quad c = 3 \cdot 10^8 \text{ m/s} \quad (1-1)$$

The speed of the light c is a constant whereas λ denotes the wavelength of the light and f denotes the frequency of the light. When light passes through for example a prism or a raindrop it diffracts. How much it diffracts is dependent on the wavelength. The larger the wavelength is, the less is the diffraction and the smaller the wavelength is, the larger is the diffraction. When white light (from the sun for example) is sent through a prism or through a raindrop it thus diffracts into a continuous spectrum which contains all visible colours from red to purple (all rainbow colours) which is sketched in Figure 1- 1.

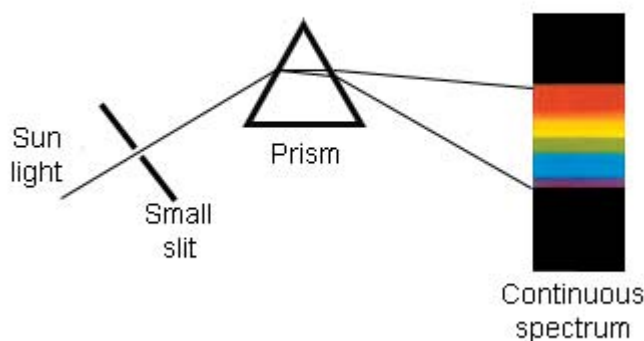

Figure 1- 1: Continuous spectrum.

Diffraction of sun light into a continuous colour spectrum.

When samples of elements are burned off, light is emitted, but this light (in contrast to a continuous spectrum) is diffracted into a so-called *line spectrum* when it passes through a prism. Such an example is sketched in Figure 1- 2.

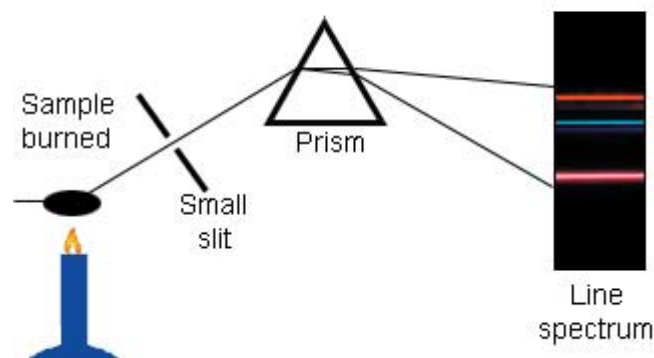

Figure 1- 2: Line spectrum.

Light from the burning off of a sample of an element diffracts into a line spectrum.

Thus only light with certain wavelengths are emitted corresponding to the individual lines in the line spectrum when an element sample is burned off. How can that be when light from the sun diffracts into a continuous spectrum? Many scientists have during the years tried to answer this question. The overall answer is that it has got something to do with the positions of the electrons relative to the atomic nucleus. We will try to give a more detailed answer by explaining different relevant theories and models concerning this phenomenon in the following sections.

Please click the advert



Brain power

By 2020, wind could provide one-tenth of our planet's electricity needs. Already today, SKF's innovative know-how is crucial to running a large proportion of the world's wind turbines.

Up to 25 % of the generating costs relate to maintenance. These can be reduced dramatically thanks to our systems for on-line condition monitoring and automatic lubrication. We help make it more economical to create cleaner, cheaper energy out of thin air.

By sharing our experience, expertise, and creativity, industries can boost performance beyond expectations. Therefore we need the best employees who can meet this challenge!

The Power of Knowledge Engineering

Plug into The Power of Knowledge Engineering.
Visit us at www.skf.com/knowledge



Download free books at BookBooN.com

1.1.3 Bohr's atomic model

Based on the line spectrum of hydrogen the famous Danish scientist Niels Bohr tried to explain why hydrogen only emits light with certain wavelengths when it is burned off. According to his theory the electrons surrounding the nucleus are only able to move around the nucleus in certain circular orbits. The single orbits correspond to certain energy levels. The orbit closest to the nucleus has the lowest energy level and is allocated with the *primary quantum number* $n = 1$. The next orbit is allocated with the primary quantum number $n = 2$ and so on. When hydrogen is in its *ground state* the electron is located in the inner orbit ($n = 1$). In Figure 1- 3 different situations are sketched. The term “photon” will be explained in the next sub section and for now a photon is just to be considered as an electromagnetic wave.

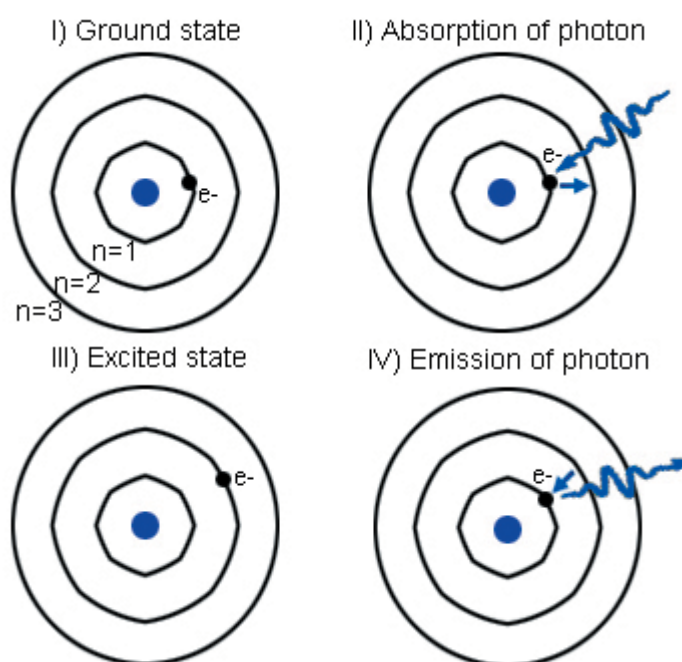

Figure 1- 3: Bohr's atomic model for hydrogen.

Sketch of the hydrogen atom according to Niels Bohr's atomic model. Only the inner three electron orbits are shown. I) The hydrogen atom in its ground state. II) The atom absorbs energy in the form of a photon. The electron is thus supplied with energy so that it can “jump” out in another orbit. III) The hydrogen atom is now in excited state. IV) The electron “jumps” back in the inner orbit. Thus the atom is again in ground state. The excess energy is released as a photon. The energy of the photon corresponds to the energy difference between the two inner orbits in this case.

If the atom is supplied with energy (for example by burning) the electron is able to “jump” out in an outer orbit ($n > 1$). Then the atom is said to be in *excited state*. The excited electron can then “jump” back into the inner orbit ($n = 1$). The excess energy corresponding to the energy difference between the two orbits will then be emitted in the form of electromagnetic radiation with a certain wavelength. This is the answer to why only light with certain wavelengths are emitted when hydrogen is burned off. The different situations are sketched in Figure 1- 3. Bohr's atomic model could explain the lines in the line spectrum of hydrogen, but the model could not be extended to atoms with more than one electron. Thus the model is considered as

being fundamentally wrong. This means that other models concerning the description of the electron positions relative to the nucleus are necessary if the line spectra are to be explained and understood. We are going to look more into such models in the sections *1.1.6 Wave functions and orbitals* and *1.1.7 Orbital configuration*, but first we have to look more at photons.

1.1.4 Photons

In section *1.1.2 Electron movement and electromagnetic radiation* electromagnetic radiation is described as continuous waves for which the connection between wavelength and frequency is given by equation (1- 1) on page 15. With this opinion of electromagnetic radiation, energy portions of arbitrary size are able to be transported by electromagnetic radiation. The German physicist Max Planck disproved this statement by doing different experiments. He showed that energy is *quantized* which means that energy *only* can be transported in portions with specific amounts of energy called *quanta*s. Albert Einstein further developed the theory of Planck and stated that *all* electromagnetic radiation is quantized. This means that electromagnetic radiation can be considered as a stream of very small “particles” in motion called *photons*. The energy of a photon is given by equation (1- 2) in which h is the Planck’s constant and c is the speed of the light.

$$E_{\text{photon}} = h \cdot \frac{c}{\lambda}, \quad h = 6.626 \cdot 10^{-34} \text{ J} \cdot \text{s}, \quad c = 3 \cdot 10^8 \text{ m/s} \quad (1- 2)$$

It is seen that the smaller the wavelength is, the larger is the energy of the photon. A photon is not a particle in a conventional sense since it has no mass when it is at rest. Einstein revolutionized the physics by postulating a connection between mass and energy. These two terms were previously considered as being *totally* independent. On the basis of viewing electromagnetic radiation as a stream of photons, Einstein stated that energy is actually a form of mass and that all mass exhibits both particle and wave characteristics. Very small masses (like photons) exhibit a little bit of particle characteristics but predominantly wave characteristics. On the other hand, large masses (like a thrown ball) exhibit a little bit of wave characteristics but predominantly particle characteristics. These considerations results in this very famous equation:

$$E = m \cdot c^2, \quad c = 3 \cdot 10^8 \text{ m/s} \quad (1- 3)$$

The energy is denoted E and hence the connection postulated by Einstein between energy and mass is seen in this equation. The previous consideration of electromagnetic radiation as continuous waves being able to transport energy with no connection to the term “mass” *can* however still find great applications since photons (as mentioned earlier) mostly exhibit wave characteristics and only to a very little extent particle (mass) characteristics. In the following example we will see how we can calculate the energy of a photon by use of some of the presented equation from this sub section.

Example 1- C:*Energy of a photon*

A lamp emits blue light with a frequency of $6.7 \cdot 10^{14}$ Hz. The energy of one photon in the blue light is to be calculated. Since the frequency of the light is known, equation (1- 1) on page 15 can be used to calculate the wavelength of the blue light:

$$c = \lambda \cdot f \Leftrightarrow \lambda = \frac{c}{f} = \frac{3 \cdot 10^8 \text{ m/s}}{6.7 \cdot 10^{14} \text{ s}^{-1}} = 4.5 \cdot 10^{-7} \text{ m}$$

This wavelength of the blue light is inserted into equation (1- 2) (from page 18):

$$E_{\text{photon}} = h \cdot \frac{c}{\lambda} = 6.626 \cdot 10^{-34} \text{ J} \cdot \text{s} \cdot \frac{3 \cdot 10^8 \text{ m/s}}{4.5 \cdot 10^{-7} \text{ m}} = 4.4 \cdot 10^{-19} \text{ J}$$

Now we have actually calculated the energy of one of the photons in the blue light that is emitted by the lamp. From equation (1- 2) it is seen that the smaller the wavelength is, the more energy is contained in the light since the photons each carries more energy.

In the next example we are going to use the famous Einstein equation (equation (1- 3) on page 18) to evaluate the stability of a tin nucleus.

Trust and responsibility

NNE and Pharmaplan have joined forces to create NNE Pharmaplan, the world's leading engineering and consultancy company focused entirely on the pharma and biotech industries.

Inés Aréizaga Esteva (Spain), 25 years old
Education: Chemical Engineer

– You have to be proactive and open-minded as a newcomer and make it clear to your colleagues what you are able to cope. The pharmaceutical field is new to me. But busy as they are, most of my colleagues find the time to teach me, and they also trust me. Even though it was a bit hard at first, I can feel over time that I am beginning to be taken seriously and that my contribution is appreciated.

Please click the advert



NNE Pharmaplan is the world's leading engineering and consultancy company focused entirely on the pharma and biotech industries. We employ more than 1500 people worldwide and offer global reach and local knowledge along with our all-encompassing list of services.
nnepharmaplan.com

nne pharmaplan[®]

Example 1- D:*Mass and energy (Einstein equation)*

From a thermodynamic point of view the stability of an atomic nucleus means that in terms of energy it is favourable for the nucleus to exist as a whole nucleus rather than split into two parts or (hypothetically thinking) exist as individual neutrons and protons. The thermodynamic stability of a nucleus can be calculated as the change in potential energy when individual neutrons and protons join and form a nucleus. As an example we are going to look at the tin isotope tin-118. Tin is element number 50 and thus this isotope contains 50 protons and $118 - 50 = 68$ neutrons in the nucleus. In order to calculate the change in energy when the nucleus is “formed” we first have to determine the change in mass when the following hypothetical reaction occurs:

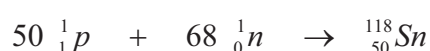

The mass on the right side of this reaction is actually not the same as the mass on the left side. First we will look at the masses and change in mass:

Mass on left side of the reaction:

$$\text{Mass}(50 \, {}_1^1p + 68 \, {}_0^1n) = 50 \cdot 1.67262 \cdot 10^{-27} \text{ kg} + 68 \cdot 1.67497 \cdot 10^{-27} \text{ kg} = 1.97526 \cdot 10^{-25} \text{ kg}$$

Mass on right side of the reaction:

$$\text{Mass}({}_{50}^{118}\text{Sn}) = \frac{117.90160 \cdot 10^{-3} \text{ kg/mol}}{6.022 \cdot 10^{23} \text{ mol}^{-1}} = 1.95785 \cdot 10^{-25} \text{ kg}$$

Change in mass when reaction occurs (tin-118 formation):

$$\text{Mass change} = 1.95785 \cdot 10^{-25} \text{ kg} - 1.97526 \cdot 10^{-25} \text{ kg} = -1.74145 \cdot 10^{-27} \text{ kg}$$

It is thus seen that when the reaction occurs and the tin-118 nucleus is formed, mass “disappears”. This change in mass can be inserted into the famous Einstein equation (equation (1- 3) on page 18) and the change in potential energy can be calculated.

$$\Delta E = \Delta m \cdot c^2 \Leftrightarrow$$

$$\Delta E = -1.74145 \cdot 10^{-27} \text{ kg} \cdot (3 \cdot 10^8 \text{ m/s})^2 = -1.6 \cdot 10^{-10} \text{ J}$$

It is seen that the “disappeared” mass has been converted into $1.6 \cdot 10^{-10}$ Joules which then are released. This corresponds to 980 MeV (1 Mega electron Volt corresponds to $1.60 \cdot 10^{-13}$ J). This amount of energy can be translated into an amount of energy pr. nucleon:

$$\Delta E = \frac{-980 \text{ MeV}}{118 \text{ neukleoner}} = -8.3 \text{ MeV / neukleon}$$

Thus it is seen that from a thermodynamic point of view it is favourable for 50 protons and 68 neutrons to join and form a tin-118 nucleus because energy can be released. The numerical value of the energy per nucleon is the energy required to break down the tin-118 nucleus into free protons and neutrons. Hence the *binding energy* per nucleon in the tin-118 nucleus is 8.3 MeV.

1.1.5 Radioactive decay

When an unstable isotope decays it means that the nucleus changes. When this happens it is because it is more favourable for the nucleus to change and then go from a higher energy level to a lower energy level. Thus energy is released when a nucleus undergoes radioactive decay and the energy is emitted as radiation. Radioactive decay mainly results in one of the three following different types of radiation:

Alpha radiation (α radiation). The radiation consists of helium nuclei (2 neutrons + 2 protons)

Beta radiation (β radiation). The radiation consists of electrons

Gamma radiation (γ radiation). The radiation is electromagnetic radiation (photons)

When a nucleus decays and alpha radiation is emitted, the nucleus loses 2 neutrons and 2 protons which correspond to a helium nucleus. When a nucleus decays and beta radiation is emitted, a neutron in the nucleus is transformed into an electron and a proton. The electron will then be emitted as beta radiation. Gamma radiation is electromagnetic radiation which (as mentioned in section 1.1.4 *Photons* on page 18) corresponds to photons. Alpha radiation is often followed by gamma radiation. When a nucleus decays it often happens in a so-called *decay chain*. This means that when a nucleus decays it is transformed into another nucleus which then again can decay into a third nucleus. This happens until a stable nucleus is formed. In the following example we will look at a radioactive decay and the emission of radiation.

Example 1- E:*Emission of alpha and gamma radiation*

The uranium isotope U-238 decays under emission of alpha radiation. Such decay can sometimes be followed by gamma radiation in the form of emission of two photons. The decay can be sketched as follows:



On the left side it is seen that the uranium isotope has 92 protons in the nucleus (corresponding to the element number of 92 for uranium). It is also seen that the uranium isotope has 238 nucleons in total in the nucleus. When an alpha particle (2 neutrons + 2 protons) is emitted the remaining nucleus only contains 90 protons and a total of 234 nucleons. When the number of protons in the nucleus changes it corresponds to that uranium has decayed into another element which in this case is thorium (Th). Thorium has the element number of 90 in the periodic table (the periodic table will be described more in details in later sections).

Alpha radiation can be followed by gamma radiation and in the case of uranium-238 decay, two gamma quantum (photons) can sometimes be emitted. These photons have different energy levels (wavelengths) and can be written as ${}_0^0\gamma$ since the photons has no mass at rest and no charge.

Please click the advert

THE MILKWAY
LAUNCHING GRADUATE CAREERS

FIRST CONTACT
Get matched to top business employers via intelligent emails landing in your inbox.

MILKROUND SYSTEM
Become a business star with internships, placements, graduate jobs & schemes from leading companies.
www.milkround.com

PLANET CAREER ADVICE
Inhabited by insights into business careers and orbited by application advice.

Milkround.com: rated the #1 graduate recruitment website in the UK Graduate Careers Survey 2009 of 16,000 university finalists.

Milkround.com

Download free books at BookBooN.com

We have now seen an example with emission of alpha and gamma radiation from the decay of uranium-238 into thorium-234. In the next example the emission for beta radiation from the unstable oxygen-20 isotope will be sketched.

Example 1- F:

Emission of beta radiation

Oxygen is very well known and the stable oxygen-18 isotope is by far the most occurring oxygen isotope (8 protons and 10 neutrons in the nucleus). The oxygen-20 isotope is however not stable and it decays under the emission of beta radiation which can be sketched as follows:

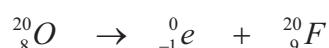

One of the neutrons in the oxygen-20 nucleus is transformed into a proton and an electron. The electron is emitted as beta radiation and because of the “extra” proton, the nucleus is now a fluor nucleus with a total of 20 nucleons. Thus the oxygen-20 isotope decays into a fluor-20 isotope. Because the electron is not a nucleon and because its mass is extremely small relative the mass of protons and neutrons, the electron is written as ${}^0_{-1}\text{e}$. The “-1” corresponds to the charge of “-1” of the electron. It is noticed that both sides of the “reaction” schema correspond, since the total number of nucleons corresponds ($20 = 0 + 20$) and the total number of charges corresponds ($8 = -1 + 9$).

It was mentioned earlier that radioactive decay often happens in *decay chains* until at stable nucleus is reached. In the following example such a decay chain will be shown.

Example 1- G:

Decay chain

As mentioned earlier radioactive decays often happen in decay chains until a stable isotope is reached. The decay of oxygen-20 can be used as an example of a decay chain:

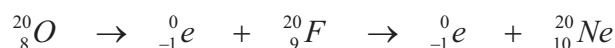

First the unstable oxygen-20 isotope decays into the unstable fluor-20 isotope under emission of beta radiation. The unstable fluor-20 isotope then decays into the stable neon-20 isotope under emission of beta radiation. Since the last reached isotope (neon-20) is stable, the decay chain ends at this point.

A decay chain can also contain a combination of alpha, beta and gamma radiation and not just beta radiation as in the example above.

1.1.6 Wave functions and orbitals

In the section *1.1.3 Bohr's atomic model* we saw that the atomic model of Niels Bohr could not be applied to atoms with more than one electron. Thus the electrons do not move around the nucleus in circular orbits as stated by Niels Bohr. In section *1.1.4 Photons* we further saw that there is a connection between energy and mass as given by the famous Albert Einstein equation. This means that electromagnetic radiation can be considered as a stream of very small particles in motion (photons) and that particles in motion can exhibit wave characteristics. Taking that into account, electrons in motion can either be considered as particles or waves. The famous scientist Erwin Schrödinger used this to derive a mathematical model (*Schrödinger wave function*) describing the probability of finding an electron in a certain location relative to the nucleus. The Schrödinger wave function for hydrogen looks as follows:

$$\frac{\partial^2 \Psi}{\partial x^2} + \frac{\partial^2 \Psi}{\partial y^2} + \frac{\partial^2 \Psi}{\partial z^2} + \frac{8\pi^2 m}{b^2} (E - V) \Psi = 0 \quad (1-4)$$

This 2nd order differential equation looks quite nasty at first sight. However we do not have to worry about having to solve this equation because it has already been done. Solutions to this equation are the so-called *wave functions* which are denoted with the symbol Ψ . The total energy of the system is denoted E , and V is the potential energy while m is the mass of the electron. The square of the wave function (Ψ^2) gives the probability of finding the electron in a certain location relative to the nucleus. There are many solutions to such a 2nd order differential equation and each solution specifies a so-called *orbital*. An orbital is thus a certain volume or area relative to the nucleus in which the probability of finding a specific electron is given by the square of the wave function (Ψ^2). Each orbital is assigned with the following three quantum numbers:

n , primary quantum number. Can have the values 1, 2, 3, ... , ∞ . The primary quantum number says something about the size and energy level of the orbital. The larger n , the larger is the orbital and the longer away the electron is relative to the nucleus.

l , angular momentum quantum number. Can have values from 0 to $n-1$. The angular momentum quantum number tells something about the shape of the orbital.

m_l , magnetic quantum number. Can have values from $-l$ to $+l$. The magnetic quantum number tells something about the orientation of the orbital in space.

Every orbital surrounding a nucleus have a unique set of these three quantum numbers which are all integers. Hence two different orbitals can never have the same combination of these three quantum numbers. In each orbital two electrons can be hosted which leads to the introduction of a fourth quantum number.

m_s , spin quantum number. Can have the value of either $-\frac{1}{2}$ or $+\frac{1}{2}$

Each of the two electrons in an orbital are thus assigned with the spin quantum number of either $-\frac{1}{2}$ or $+\frac{1}{2}$. This means that each electron in an atom is assigned with a total of four quantum numbers. The first three quantum numbers (n , l and m_l) tell which orbital the electron is placed in, while the last quantum number (the spin quantum number m_s) is just introduced in order to give each electron its unique set of quantum numbers. Since two electrons can be hosted in one orbital there is a need for the spin quantum number. The fact that

each electron has its own unique set of quantum numbers is called *Pauli's exclusion principle*. If only one electron is hosted in an orbital this electron is said to be unpaired. An element which has unpaired electrons in one or more orbitals is said to be *paramagnetic*. On the other hand an element without unpaired electrons is said to be *diamagnetic*.

Paramagnetic atom: An atom that has unpaired electrons in one or more orbitals

Diamagnetic atom: An atom that has *no* unpaired electrons in its orbitals.

1.1.7 Orbital configuration

As mentioned in section 1.1.6 *Wave functions and orbitals* the angular momentum quantum number l determines the shape of the orbital while the magnetic quantum number m_l determines the orientation of the orbital relative to the nucleus. Each orbital is designated with a letter dependent of the value of the angular momentum quantum number l :

$l = 0$, orbital is designated with the letter s .	$m_l = 0$	(1 orbital)
$l = 1$ orbital is designated with the letter p .	$m_l = -1, 0, +1$	(3 orbitals)
$l = 2$, orbital is designated with the letter d .	$m_l = -2, -1, 0, 1, 2$	(5 orbitals)
$l = 3$, orbital is designated with the letter f .	$m_l = -3, -2, -1, 0, 1, 2, 3$	(7 orbitals)

Please click the advert

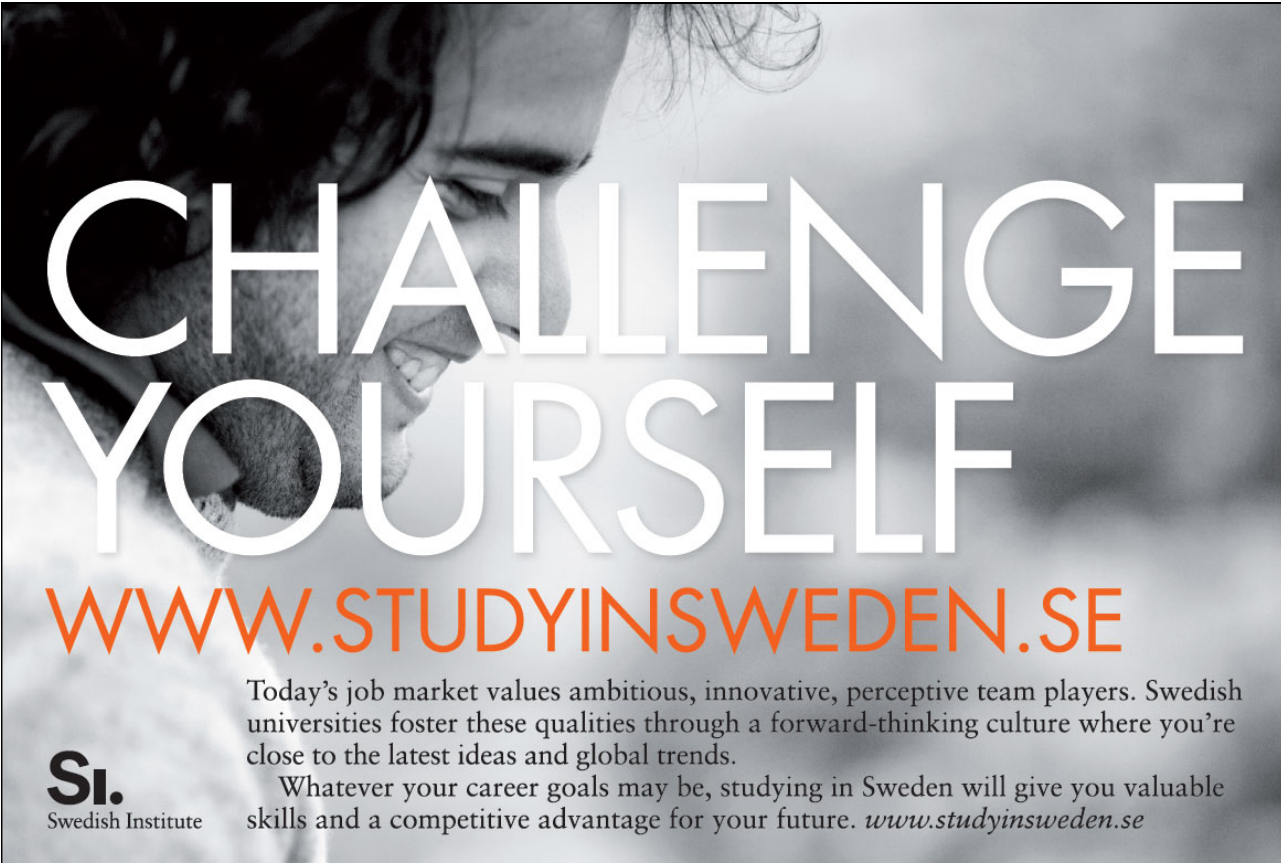

CHALLENGE YOURSELF

WWW.STUDYINSWEDEN.SE

Today's job market values ambitious, innovative, perceptive team players. Swedish universities foster these qualities through a forward-thinking culture where you're close to the latest ideas and global trends.

Whatever your career goals may be, studying in Sweden will give you valuable skills and a competitive advantage for your future. www.studyinsweden.se

Si.
Swedish Institute

Download free books at BookBooN.com

Although the angular momentum quantum number l can attain larger values than “3” (there should thus be more than the four orbital types; s , p , d and f) it is only in those four mentioned types of orbital electrons are hosted. In Figure 1- 4 sketches of the s -, p - and d -orbitals are shown.

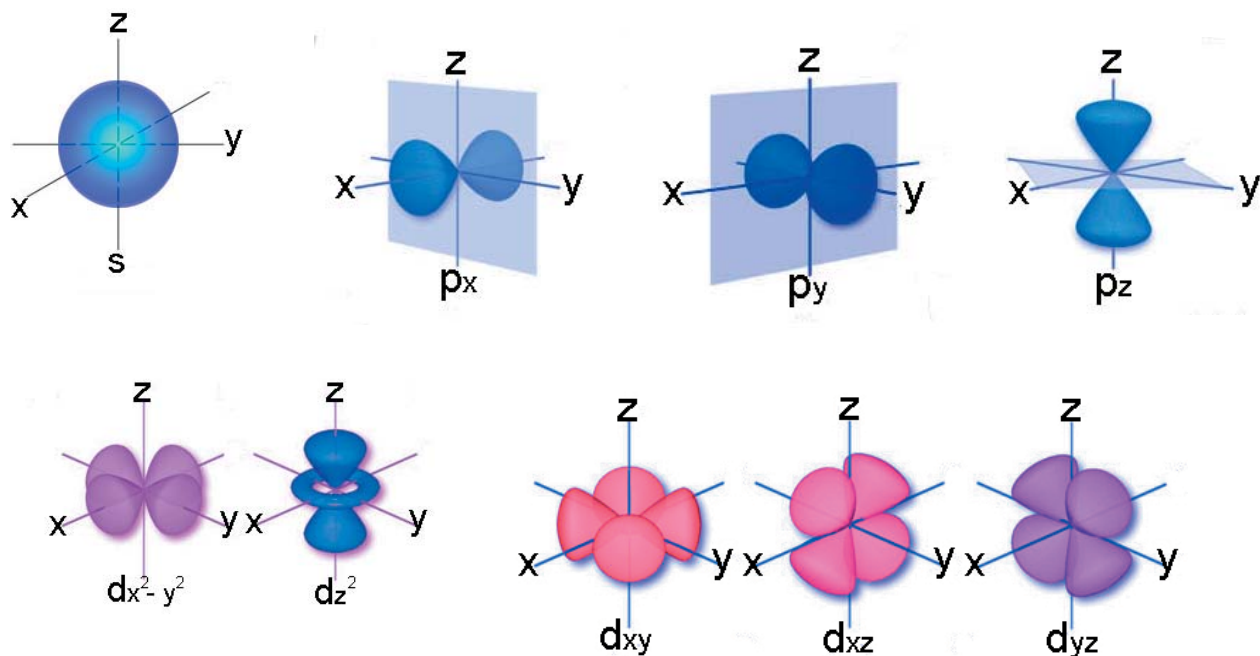

Figure 1- 4: Geometry of the orbitals

Sketch of the one s -orbital, the three p -orbitals and the five d -orbitals. The seven f -orbitals are not shown. The “names” of the different orbitals are given below each orbital.

In the following example we are going to look at the designation of letters and quantum numbers for different orbitals.

Example 1- H:*Quantum numbers and designations for different orbitals*

We are going to list the different possible quantum numbers when the primary quantum number n has the value of 4. We are also going to assign the orbitals with letter symbols.

When $n = 4$, the angular momentum quantum number l can assume the values of 0, 1, 2 or 3. For each value of l the magnetic quantum number m_l can attain the values from $-l$ to $+l$. This is sketched in Figure 1- 5.

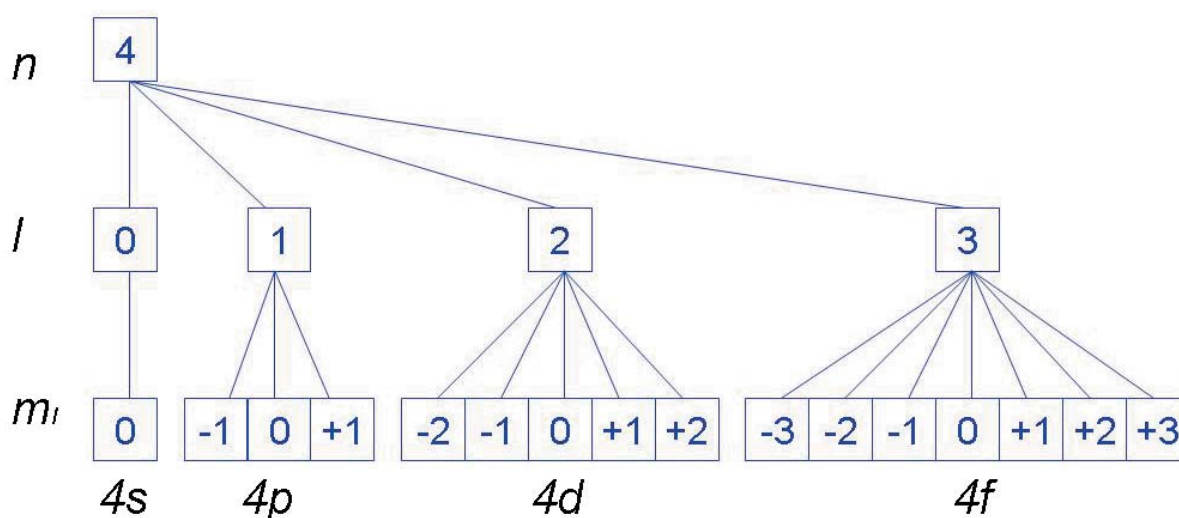
**Figure 1- 5: Listing of orbitals**

The individual orbitals for the primary quantum number $n = 4$.

It is thus seen that when the primary quantum number has the value of 4 it gives a total of 16 “4-orbitals” which are the *one* 4s-orbital, the *three* 4p-orbitals, the *five* 4d-orbitals and the *seven* 4f-orbitals.

The Schrödinger's wave equation has thus resulted in a theory about orbitals that host electrons. This model is, contradictory to the atomic model of Niels Bohr, also applicable for atoms with more than one electron (elements other than hydrogen). The lines in the line spectrums are explained by postulating that an electron in excited state have one or more electrons that have “jumped” out in an outer atomic orbital with larger energy. When this or these electrons then “jump” back into the orbitals of lower energy, energy is emitted in the form of photons. The energy (wavelength) of these photons then corresponds to the energy difference between the two affected orbitals and hence only light with certain wavelengths can be emitted when for example element samples are burned off. This is pretty much the same principle as explained by Niels Bohr, the difference is just that the electrons are “*now*” hosted in orbitals instead of circular orbits.

It is important to emphasize that orbitals are areas/volumes in which the electrons with a certain probability can be found. Orbitals are derived from mathematical models and the concept of orbitals is developed in order to be able to explain certain characteristics of the element such as the line spectra. Thus we are talking about theoretical and mathematical description of probabilities of finding electrons in certain areas and this

description has turned out to be useful to explain certain characteristics. In chapter 2 we will see that the orbital theory is very useful in describing how different atoms join together and form chemical bonds which lead to the formation of molecules.

1.2 Construction of the periodic table

In section 1.1 *Atomic nucleus, electrons and orbitals* we saw that an atom in its ground state consists of an equal amount of electrons and protons and that the electrons are located around the nucleus in different orbitals. These orbitals have different levels of energy which determine where the individual electrons will be hosted. In this section we are going to look at how the elements are arranged the periodic table and why the periodic table has its actual configuration.

1.2.1 Aufbau principle

The elements in the periodic table are placed according to increasing atomic number. The atomic number corresponds to the number of protons in the nucleus which also corresponds to the number of electrons surrounding the nucleus in its ground state. The horizontal rows in the periodic table are called *periods*. The first period is related to the primary quantum number $n = 1$, the second period is related to the primary quantum number $n = 2$ and so on which is sketched in Figure 1- 6.

Please click the advert



oxygen.ie

Download 3rd level revision guides for free
– brought to you by oxygen.ie

Download free books at BookBooN.com

	MAIN GROUP ELEMENTS										MAIN GROUP ELEMENTS							
1st period	H																	He
2nd period	Li	Be	TRANSITION METALS										B	C	N	O	F	Ne
3rd period	Na	Mg											Al	Si	P	S	Cl	Ar
4th period	K	Ca	Sc	Ti	V	Cr	Mn	Fe	Co	Ni	Cu	Zn	Ga	Ge	As	Se	Br	Kr
5th period	Rb	Sr	Y	Zr	Nb	Mo	Tc	Ru	Rh	Pd	Ag	Cd	In	Sn	Sb	Te	I	Xe
6th period	Cs	Ba	La	Hf	Ta	W	Re	Os	Ir	Pt	Au	Hg	Tl	Pb	Bi	Po	At	Rn
7th period	Fr	Ra	Ac	Rf	Db	Sg	Bh	Hs	Mt	Ds	Rg							
LANTHANOIDS	Ce Pr Nd Pm Sm Eu Gd Tb Dy Ho Er Tm Yb Lu																	
ACTINOIDS	Th Pa U Np Pu Am Cm Bk Cf Es Fm Md No Lr																	

Figure 1- 6: The periodic table

The dotted lines indicated the insertion of the lanthanoids and the actinoids.

Each period is finished with one of the noble gasses (He, Ne, Ar, Kr, Xe and Rn). The noble gasses are characterized by the fact that each orbital related to that specific period is filled with 2 electrons. This makes the noble gasses particularly stable and not very reactive or willing to join in chemical compounds with other elements. The periodic table is constructed according to the so-called *aufbau principle* in which the elements from number 1 to number 111 are placed periodically by “filling” and extra electron in the “next” available orbital with the lowest possible energy level. Thus one moves from the left to the right in each period during the filling of one extra electron at each position in the periodic table. The elements are thus arranged according to their so-called *electron configuration* which is a concept we are going to look more into in the following section.

1.2.2 Electron configuration

To go from one element to the next in the periodic table, one electron is “filled” in the next available orbital with the lowest possible energy level (and one more proton will be present in the nucleus). We know that each orbital is able to host two electrons. When all the orbital of one period are filled, a new period is started according to the *aufbau principle*. The last “attached” electron or electrons for that specific period are called *valence electrons* or *bond electrons*. In Figure 1- 7 you can see in which orbitals the outer electrons of a given element are hosted. For example for the 4th period you have the following order of orbitals:

$$4^{\text{th}} \text{ period orbital order : } 4s - 3d - 4p$$

It is the valence or bond electrons that are used when atoms join together and form chemical bonds and molecules. This will be described in details in chapter 2.

1st period	1s								1s
2nd period	2s								2p
3rd period	3s								3p
4th period	4s					3d			4p
5th period	5s					4d			5p
6th period	6s		4f			5d			6p
7th period	7s		5f			6d			

Figure 1- 7: Orbitals associated with the periodic table

The different outer orbitals of the different periods and groups.

The orbitals are filled with electrons according to the *aufbau principle* from the left to the right in each period. The orbitals with lowest energy level are filled first. The orbitals can be ordered according to increasing energy level in the following row:

$$1s < 2s < 2p < 3s < 3p < 4s < 3d < 4p < 5s < 4d < 5p < 6s < 4f < 5d < 6p < 7s < 5f < 6d \quad (1- 5)$$

The orbitals with lowest energy level are filled first. The following examples sketch the electron configuration for all elements. That way the *aufbau principle* and construction of the periodic table will be clear.

Example 1- I:

Filling of electrons in the 1st period

The primary quantum number n equals 1 in the 1st period which means that only one orbital appears in this period and that this is an s-orbital (see section 1.1.7 *Orbital configuration* and Figure 1- 7 on page 30). According to Pauli's exclusion principle only two electrons can be hosted in one orbital which means that only two elements can be present in the 1st period. Element number 1 is hydrogen and its electron is placed in the 1s-orbital since this orbital has the lowest energy level according to the row presented in (1- 5) on page 30. Helium is element number 2 and its two electrons are also placed in the 1s-orbital. The electron configurations for the 1st period elements are written as follows:

$H, 1s^1$, hydrogen has 1 electron which is hosted in the 1s-orbital.

$He, 1s^2$, helium has 2 electrons which are hosted in the 1s-orbital.

Example 1- J:*Filling of electrons in the 2nd period*

The 1st period is ended when the 1s-orbital is filled. The 2nd period is then started when more electrons are added. According to the row given in (1- 5) on page 30 and to Figure 1- 7 on page 30 the filling of electrons in the 2nd period starts with the 2s-orbital. The electron configurations look as follows:

Li, $1s^2 2s^1$, lithium has 2 electrons in the 1s-orbital and 1 electron in the 2s-orbital.

Be, $1s^2 2s^2$, beryllium has 2 electrons in the 1s-orbital and 2 electron in the 2s-orbital.

Beryllium has two filled orbitals (1s- and the 2s-orbital) but this is not the end of the 2nd period since there are three 2p-orbitals to be filled before the period is ended. The filling of electrons in the three 2p-orbitals is to be started:

B, $1s^2 2s^2 2p^1$, boron has 2 electrons in the 1s-orbital, 2 electrons in the 2s-orbital and 1 electron in one of the three 2p-orbitals.

C, $1s^2 2s^2 2p^2$, carbon has 2 electrons in the 1s-orbital, 2 electron in the 2s-orbital and 2 single unpaired electrons in two of the 2p-orbitals.

According to *Hund's rule* it is most favourable in terms of energy for electrons to stay unpaired in degenerated orbitals. What does that mean?

For example the three 2p-orbitals are degenerated which means that they all have equal levels of energy. To put it another way; it does not matter in which of the three 2p-orbitals the last "attached" valence electron is placed in. *Hund's rule* implies that in terms of energy it is most favourable for the electron to be placed in an empty 2p-orbital whereby the electron remains unpaired (that way the atom will be paramagnetic according to what is stated in section 1.1.6 *Wave functions and orbitals*. When all 2p-orbitals are filled with single unpaired electrons you have the element nitrogen with the following electron configuration:

N, $1s^2 2s^2 2p^3$, according to Hund's rule each of the three 2p-orbitals are each filled with a single unpaired electron.

To get to the next element which is oxygen, an extra electron is filled in one of the 2p-orbitals. That way there are only two unpaired electrons left. The filling of electrons in the rest of the 2nd period is sketched below:

O, $1s^2 2s^2 2p^4$, 2 unpaired electrons in two of the 2p-orbitals. Paramagnetic.

F , $1s^2 2s^2 2p^5$, 1 unpaired electron in one of the $2p$ -orbitals. Paramagnetic.

Ne , $1s^2 2s^2 2p^6$, all orbitals of the period are filled and the period is ended. Diamagnetic.

The last attached electron or electrons in the period are (as mentioned earlier) called valence electrons or bond electrons. If fluor is used as an example the valence electrons are the two electrons in the $2s$ -orbital and the five electrons in the $2p$ -orbitals. The two inner electrons in the $1s$ -orbital are not valence electrons. They are called *core electrons* instead.

Please click the advert



DIVERSE - INNOVATIVE - INTERNATIONAL

Are you considering a European business degree?

Copenhagen Business School is one of the largest business schools in Northern Europe with more than 15,000 students from Europe, North America, Australia and Asia.

Are you curious to know how a modern European business school competes with a diverse, innovative and international study environment?

Please visit Copenhagen Business School at www.cbs.dk

Copenhagen Business School
HANDELSHØJSKOLEN

Diversity creating knowledge

Accredited by Association of MBAs

EFMD EQUIS ACCREDITED

MEMBER OF CEMS

Example 1- K:*Filling of electrons in the 3rd period*

The 2nd period is ended with the noble gas neon. After neon the 3rd period is started with the 3s-orbital:

Na, $1s^2 2s^2 2p^6 3s^1$, one valence electron in the 3s-orbital and 10 *core electron*.

The electron configuration for the 10 core electrons corresponds to the electron configuration for the noble gas in the previous period (in the case of sodium the core electron configuration corresponds to the electron configuration of neon). To ease the work of writing the full electron configuration, only the electron configuration of the valence electrons are written while the electron configuration for the core electrons is replaced by the chemical symbol for the previous noble gas placed in edged brackets. The electron configuration for sodium can thus more simple be written as follows:

Na, $[Ne]3s^1$, one valence electron in the 3s-orbital. The electron configuration for 10 core electrons correspond the electron configuration of the noble gas neon.

The filling of valence electrons in the 3rd period is continued as in the 2nd period:

Mg, $[Ne]3s^2$, 2 electrons in the 3s-orbital.

Al, $[Ne]3s^2 3p^1$, 2 electrons in the 3s-orbital and one electron in one of the 3p-orbitals.

Si, $[Ne]3s^2 3p^2$, 2 electrons in the 3s-orbital and 2 unpaired electrons in two of the 3p-orbitals.

P, $[Ne]3s^2 3p^3$, 2 electrons in the 3s-orbital and 3 unpaired electrons in three of the 3p-orbitals.

S, $[Ne]3s^2 3p^4$, 2 electrons in the 3s-orbital and 4 electrons in the 3p-orbitals.

Cl, $[Ne]3s^2 3p^5$, 2 electrons in the 3s-orbital and 5 electrons in the 3p-orbitals.

Ar, $[Ne]3s^2 3p^6 = [Ar]$, all orbitals of the period are filled and we have reached the end of the 3rd period.

Example 1- L:*Filling of electrons in the 4th period*

The filling of valence electrons through the 4th period takes place almost as in the 3rd period. The exception is that after the filling of the 4s-orbital, the five 3d-orbitals are then filled before the filling of the three 4p-orbitals according to the row given in (1- 5) on page 30 and Figure 1- 7 on page 30. This is due to the fact that in between the energy levels of the 4s-orbital and the 4p-orbitals the energy level of the five 3d-orbitals is located. During the filling of the five 3d-orbitals, Hund's rule is again followed which means that as long as there are empty 3d-orbitals the "next" electron will be placed in an empty orbital and thus remain unpaired. Some examples of electron configuration for elements from the 4th period are given here:

Ti, $[Ar]4s^2 3d^2$, 2 electrons in the 4s-orbital and 2 electrons in the 3d-orbitals.

Zn, $[Ar]4s^2 3d^{10}$, all five 3d-orbitals are filled.

Ga, $[Ar]4s^2 3d^{10} 4p^1$, the filling of the three 4p-orbitals has started.

Kr, $[Ar]4s^2 3d^{10} 4p^6 = [Kr]$, all the orbitals of the period are filled and the period is ended.

In the 4th period there are some exceptions for some of the elements where the electron configuration deviates for the conventional principle of "filling". These exceptions are:

Cr, $[Ar]4s^1 3d^5$, only *one* electron in the 4s-orbital while all five 3d-orbitals each host one unpaired electron. This configuration gives a particular stable configuration for the d-orbitals

Cu, $[Ar]4s^1 3d^{10}$, only *one* electron in the 4s-orbital while all five 3d-orbitals each host two electrons.

This configuration gives a particular stable configuration for the d-orbitals.

Example 1- M:*Filling of electrons in the 5th period*

The filling of electrons through the 5th period takes place exactly as for the 4th period. First the 5s-orbital is filled and then the five 4d-orbitals are filled. Finally the three 5p-orbitals are filled according to the row given in (1- 5) on page 30 and Figure 1- 7 on page 30. In the 5th period there are also some deviations for the normal filling principles in which the five 4d-orbitals are either half or completely filled with electrons before the 5s-orbital is filled. These deviations are similar to the deviations in the 4th period:

Mo, $[Kr]5s^1 4d^5$, only *one* single electron in the 5s-orbital while all five 4d-orbitals each host one unpaired electron. This gives a particular stable electron configuration for the d-orbitals.

Pd, $[Kr]5s^0 4d^{10}$, *no* electrons in the 5s-orbital while all five 4d-orbitals each host two electrons. This gives a particular stable electron configuration for the d-orbitals

Ag, $[Kr]5s^1 4d^{10}$, only *one* single electron in the 5s-orbital while all five 4d-orbitals each host two electrons. This gives a particular stable electron configuration for the d-orbitals.

Please click the advert



Sharp Minds - Bright Ideas!

Employees at FOSS Analytical A/S are living proof of the company value - First - using new inventions to make dedicated solutions for our customers. With sharp minds and cross functional teamwork, we constantly strive to develop new unique products - Would you like to join our team?

FOSS works diligently with innovation and development as basis for its growth. It is reflected in the fact that more than 200 of the 1200 employees in FOSS work with Research & Development in Scandinavia and USA. Engineers at FOSS work in production, development and marketing, within a wide range of different fields, i.e. Chemistry, Electronics, Mechanics, Software, Optics, Microbiology, Chemometrics.

We offer
A challenging job in an international and innovative company that is leading in its field. You will get the opportunity to work with the most advanced technology together with highly skilled colleagues.

Read more about FOSS at www.foss.dk - or go directly to our student site www.foss.dk/sharpminds where you can learn more about your possibilities of working together with us on projects, your thesis etc.

The Family owned FOSS group is the world leader as supplier of dedicated, high-tech analytical solutions which measure and control the quality and production of agricultural, food, pharmaceutical and chemical products. Main activities are initiated from Denmark, Sweden and USA with headquarters domiciled in Hillerød, DK. The products are marketed globally by 23 sales companies and an extensive net of distributors. In line with the corevalue to be 'First', the company intends to expand its market position.





Dedicated Analytical Solutions

FOSS
 Slangerupgade 69
 3400 Hillerød
 Tel. +45 70103370
www.foss.dk

Example 1- N:

Filling of electrons in the 6th and 7th period

In the 6th and 7th period the seven f-orbitals are introduced (the 4f-orbitals and the 5f-orbitals respectively) which is also sketched in (1- 5) on page 30 and Figure 1- 7 on page 30. This means that in the 6th period the 6s-orbital is filled first and then the seven 4f-orbitals are filled. After that the five 5d-orbitals are filled follow by the filling of the three 6p-orbitals. In the 7th period the 7s-orbital is filled first followed by the filling of the seven 5f-orbitals. After that the five 6d-orbitals are filled and then no more elements exist (or at least they are not found or synthesized yet).

Here are some examples of electron configurations for 6th and 7th period elements. Europium (Eu), gold (Au), lead (Pb) and einsteinium (Es) are used as examples:

Eu, $[Xe]6s^2 4f^7$, core electron configuration corresponds to the noble gas xenon. Besides that 2 electrons are in the 6s-orbital and 7 unpaired electrons in each of the seven 4f-orbitals.

Au, $[Xe]6s^1 4f^{14} 5d^{10}$, core electron configuration corresponds to the noble gas xenon. Besides that *one* electron is in the 6s-orbital, 14 electrons in the 4f-orbitals and 10 electrons in the 5d-orbitals. It is seen that the electron configuration of gold deviates from the normal “filling” principle since only *one* electron is in the 6s-orbital the 5d-orbitals are filled. But as described for the 4th and 5th period this gives a particular stable configuration for the d-orbitals.

Pb, $[Xe]6s^2 4f^{14} 5d^{10} 6p^2$, core electron configuration corresponds to the noble gas xenon. Besides that 2 electrons in the 6s-orbital, 14 electrons in the 4f-orbitals, 10 electrons in the 5d-orbitals and 2 electrons in the 6p-orbital.

Es, $[Rn]7s^2 5f^{11}$, core electron configuration corresponds to the noble gas radon. Besides that there are 2 electrons in the 7s-orbital and 11 electrons in the 5f-orbitals.

The elements with 4f-orbital valence electrons are called *lanthanoids* because the first element before the 4f-orbitals is lanthanum (La). The elements with 5f-orbital valence electrons are called *actinoids* since the first element before the 5f-orbitals is actinium (Ac).

1.2.3 Categorization of the elements

The elements in the periodic table can be classified at either

Metals

Half-metal or

None-metal

The metals are placed to the left while the none-metals are placed to the right in the periodic table. The half-metals are placed as a wedge between the metals and the none-metals as sketched in Figure 1- 8.

ALKALI METALS (NOT HYDROGEN)		ALKALINE EARTH METALS		TRANSITION METALS										HALOGENS					NOBLE GASSES	
1.	H																		He	
2.	Li	Be											B	C	N	O	F		Ne	
3.	Na	Mg											Al	Si	P	S	Cl		Ar	
4.	K	Ca	Sc	Ti	V	Cr	Mn	Fe	Co	Ni	Cu	Zn	Ga	Ge	As	Se	Br		Kr	
5.	Rb	Sr	Y	Zr	Nb	Mo	Tc	Ru	Rh	Pd	Ag	Cd	In	Sn	Sb	Te	I		Xe	
6.	Cs	Ba	La	Hf	Ta	W	Re	Os	Ir	Pt	Au	Hg	Tl	Pb	Bi	Po	At		Rn	
7.	Fr	Ra	Ac	Rf	Db	Sg	Bh	Hs	Mt	Ds	Rg									
LANTHANOIDS			Ce	Pr	Nd	Pm	Sm	Eu	Gd	Tb	Dy	Ho	Er	Tm	Yb	Lu				
ACTINOIDS			Th	Pa	U	Np	Pu	Am	Cm	Bk	Cf	Es	Fm	Md	No	Lr				

Figure 1- 8: Categorization of the elements in the periodic table

The elements can be categorized as metals, half-metals or none-metals. Common names for some of the vertical groups are given as well.

One of the most important differences between metals and none-metals is that metals have very high electrical conductance in all directions. Carbon for example in the form of graphite only conducts electricity in two dimensions inside the layered structure and is thus characterized as a none-metal. Metals and none-metals also behave very different in association with chemical reactions and the formation of chemical bonds. When a metal reacts with a none-metal, the metal will normally deliver electrons to the none-metal which makes the metal into a cation. The none-metal is thus made into an anion and the chemical bond will thus be ionic. The half-metals are placed as a wedge between the metals and none-metals. The half-metals exhibit both metal characteristics and none-metal characteristics.

The vertical rows in the periodic table are called groups. The elements with the “last attached” electron in a d-orbital are called transition metals while the lanthanoids and actinoids have their “last attached” electron in the 4f-orbitals and 5f-orbitals respectively. The other groups are normally called *main groups*. Some of these groups have common names which are shown in Figure 1- 8. The transitions metals in the “middle” (closest to manganese (Mn), Technetium (Tc) and Rhenium (Re)) are generally characterized by the ability to appear in almost all oxidations states, whereas the main group elements in general only are able to appear in one or two different oxidation states besides the oxidation state of zero. This is exemplified in the following example:

Example 1- O:

Oxidation state (transition metal and main group element)

Transition metals are among other aspects characterized by the ability to appear in many oxidation states. The transition metal osmium can be used as an example:

Os, Possible oxidation states of osmium: 0, +2, +3, +4, +6, +8

It is thus seen that osmium can attain six different oxidation states. On the other hand main group elements are generally not able to attain that many different oxidation states. Tin for example can only attain two different oxidation states (besides from zero):

Sn, Possible oxidation states of tin: 0, +2, +4

The general trend is that transition metals can attain many different oxidation states which are contradictory to main group elements that in general only can attain a few different oxidation states.

Please click the advert

**Design your
own future at
MAN Diesel**

www.mandiesel.com

MAN Diesel – Powering the World



Download free books at BookBooN.com

1.2.4 Periodic tendencies

Different tendencies for the elements are present for the periods (horizontal rows) in the periodic system and different tendencies are present in the groups (vertical rows) in the periodic table. In this section we will look more at the periodic tendencies for the following three terms:

Atomic radius

Ionization energy

Electron affinity

The general trends will be described in this section and only some of the exceptions that appear in the periodic table will be discussed. For more details about all exceptions you should seek the knowledge in more detailed educational textbooks.

The radius of an atom decreases when you go from the left to the right through a period. This is because when one moves one position to the right (for example when going from lithium to beryllium) one more proton is “added” to the atomic nucleus. Also one electron is “added”. This extra electron will just be hosted in one of the existing orbitals of the period and will not lead to an increased volume. However the “extra” proton in the nucleus will increase the total positive charge of the nucleus by “+1”. This means that the increased positive charge will drag the electrons closer to the nucleus and the total volume and atomic radius will thus decrease.

When you move down a group (vertical row) in the periodic table the atomic radius will of course increase since the atom just below has more electrons and a set of orbital more (*s*- and *p*-orbitals and eventually *d*- and *f*-orbitals). When you move one position down, the primary quantum number *n* will increase by 1 and this means that the orbitals for that particular quantum number are larger which results in a larger atomic radius since the valence electrons are then placed further away from the nucleus. We will look more at atomic radius in the following example:

Example 1- P:*Atomic radius*

When you move through a period from the right to the left the atomic radius will decrease. This is sketched for the 3rd period in Figure 1- 9.

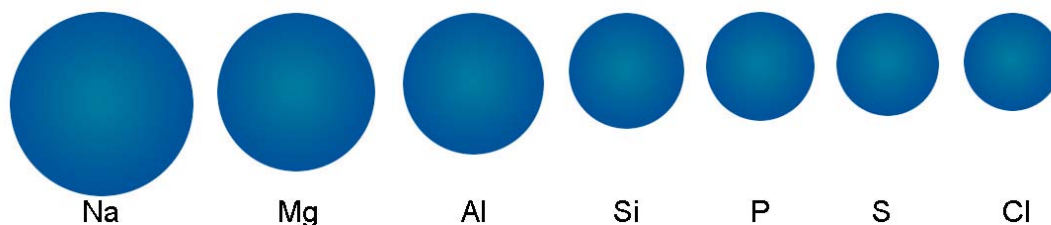

Figure 1- 9: Relative atomic radius for 3rd period elements

Relative atomic radius for the elements in the 3rd period of the periodic table.

It is seen that the atomic radius for sodium is almost the double of that of chlorine. When you move down a group (vertically down) the atomic radius increases which is sketched in Figure 1- 10 for the elements in the 1st main group.

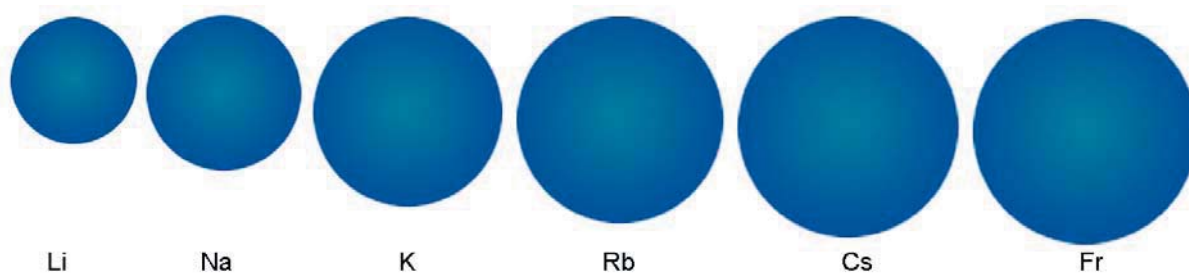

Figure 1- 10: Relative atomic radius for 1st main group elements

Relative atomic radius for the elements in the 1st main group.

In Figure 1- 10 it is seen that the relative atomic radius for the elements in the 1st main group (alkali metals) increases which is the case for all vertically groups.

Now we are going to look at ionization energy. When we talk about ionization energy it is implicit that we are talking about the 1st ionization energy. The 1st ionization energy is the amount of energy required to remove one single electron away from the atom. When one electron is removed the atom becomes a positively charged ion (a cation). Tin and boron can be used as examples:



Thus 708.2 and 800.6 kilo joules are required to ionize 1 mole of tin and boron atoms respectively. When you move from the left to the right in a period in the periodic table the ionization energy increases. This is because the further you are to the right the more protons are present in the nucleus and the larger a positive charge will then drag the electrons towards the nucleus. Thus more energy is required to remove an electron when the larger positive nucleus charge drags the electrons. When you move down a group in the periodic table the ionization energy decreases. This is because the further down the group you are, the further away from the nucleus the valence electrons are placed. Thus the electrons further away from the nucleus are easier to remove and thus the ionization energy decreases. Furthermore the electrons closer to the nucleus constitute a kind of shielding or screening for the outer electrons. Thus the outer electrons are not that much attracted by the nucleus because of this shielding and they are therefore easier to remove and the ionization energy is lower. In the following example we will look more at ionization energies.

Please click the advert

The advertisement features a light blue background with a central graphic. The graphic consists of four icons arranged horizontally, separated by plus signs and an equals sign. From left to right: a shopping cart icon on a dark grey background labeled 'Student Discounts'; a calendar icon on a blue background labeled 'Student Events'; a pound sterling symbol (£) on a grey background labeled 'Money Saving Advice'; and a yellow envelope icon with three stars on a yellow background labeled 'Happy Days!'. Below the icons, the text 'wealthystudent.co.uk' is displayed in a dark grey font, with 'wealthy' in a larger, bold font and 'student.co.uk' in a smaller font.

Download free books at BookBooN.com

Example 1- Q:*Ionization energy*

The ionization energy increases when you move from the left to the right in a period. In Figure 1- 11 the ionization energies for the elements of the 2nd period are showed as an example. The ionization energy decreases when you move down a group in the periodic table. This is also shown in Figure 1- 11 for the elements of the 1st main group (the alkali metals).

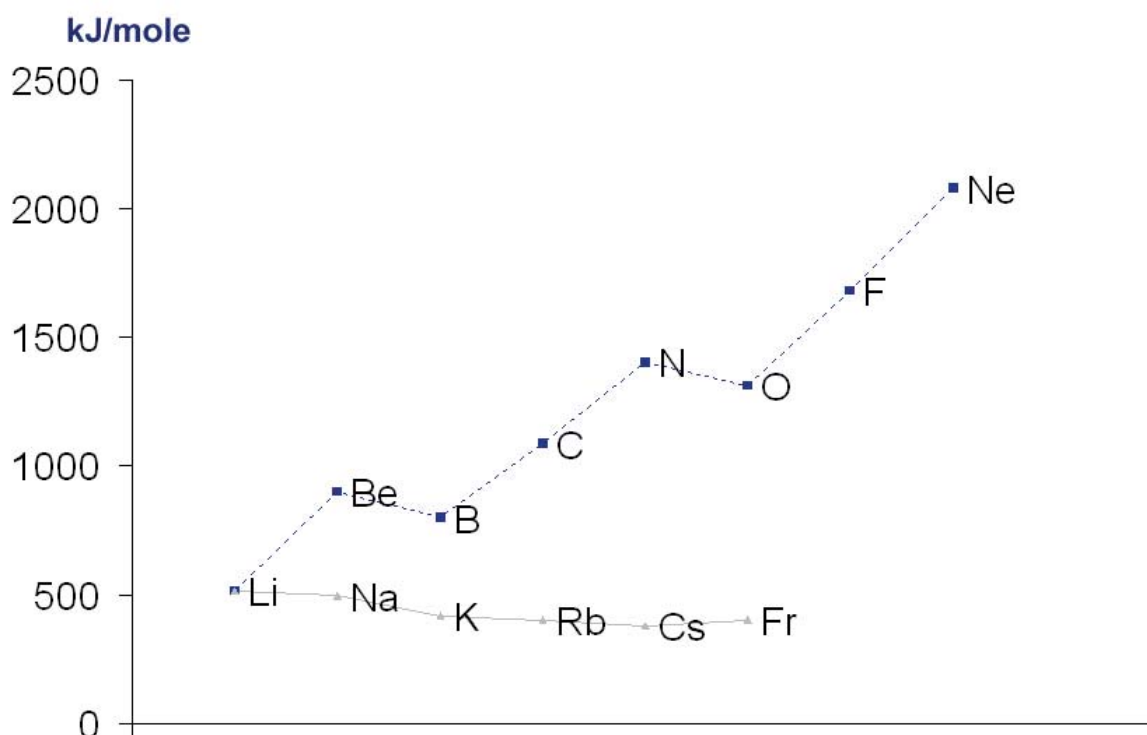
**Figure 1- 11: Ionization energy**

Ionization energy for the elements in the 2nd period (Li, Be, B, C, N, O, F and Ne) and for the elements in the 1st main group (Li, Na, K, Rb, Cs and Fr).

Two exceptions are clear by looking at Figure 1- 11. When you go from beryllium to boron the ionization energy actually decreases. This is because the valence electron of boron in one of the 2p-orbitals is easier to remove than one of the valence electrons of beryllium in the 2s-orbital. The two electrons in the beryllium 2s-orbital constitute a particularly stable electron configuration and the ionization energy is thus relatively large. Nitrogen has three unpaired electrons in each of the degenerated 2p-orbitals which (as described in the section 1.2.2 *Electron configuration*) gives a particularly stable electron configuration. Hence more energy is required to remove one of these unpaired 2p-electrons than the amount of energy required to remove one of the paired 2p-electrons of the oxygen atom. Therefore the ionization energy of oxygen is lower than for nitrogen.

Overall it is seen that the increasing tendency of ionization energy for the periods is much larger than the decreasing tendency down the vertically groups.

Electron affinity is defined as the energy change when an electron is attached to an element. Fluor can be used as an example:



Since the electron affinity is negative, 328 kilo joules are released when 1 mole of electrons are attached to 1 mole of fluor atoms. This relatively large number is caused by the very high electronegativity of fluor. It tells something about the tendency for the atom to accept an extra electron. Electron affinity is thus related to the electronegativity of the elements. In Figure 1- 12 the relative electronegativity for the elements in the periodic table is sketched.

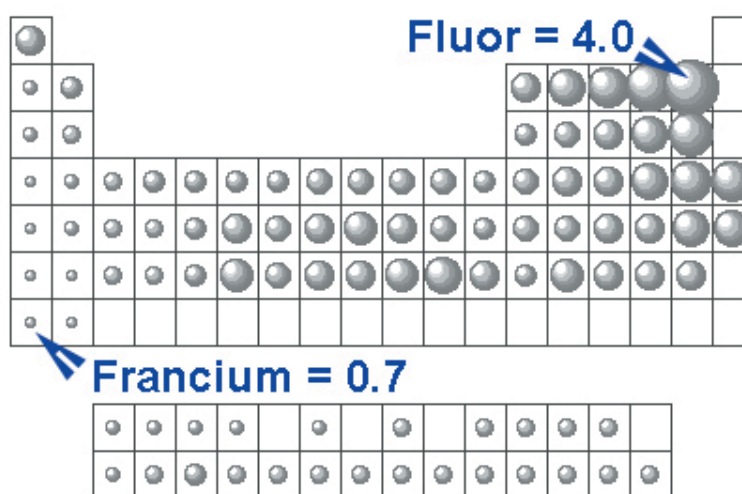

Figure 1- 12: Electronegativity

Electronegativity of the elements in the periodic table. The size of the “bubbles” corresponds to the relative level of the electronegativity. Fluor has the largest electronegativity (4.0) and francium has the lowest electronegativity (0.7).

The larger electronegativity the more the atom ”wants” to adopt an extra electron and the larger a numerical value of the electron affinity. It shall be noticed that all elements have positive electronegativities which means that in principle all elements can benefit from adopting an electron in terms of energy. But here is shall be noted that this extra electron has to be supplied from another atom and that this atom thus has to be lower in electronegativity in order for the total energy to be lowered. In the following example we are going to look more at electronegativities and electron affinities.

Example 1- R:*Electronegativity*

You have a rubidium atom (Rb) and an iodine atom (I). Both have positive electronegativities which mean that both in principle want to adopt an extra electron. Which of the atoms will become a cation and which will become an anion if they react with each other? Which of the atoms have largest electron?

Rubidium has an electronegativity of 0.8 and iodine has an electronegativity of 2.5. Thus iodine is more likely to adopt an electron than rubidium. Thus rubidium will be forced to deliver an electron to iodine during a chemical reaction.

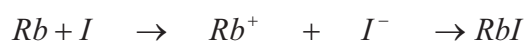
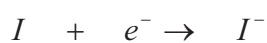

Because iodine has larger electronegativity than rubidium, the numerical value of the electron affinity for iodine will be larger than for rubidium. This is the reason that during chemical reaction the iodine atom will become the anion (iodide) and rubidium will become the cation (rubidium ion).

Please click the advert



Read The Spanner online on oxygen.ie

Download free books at BookBooN.com

1.3 Summing up on chapter 1

In this first chapter the fundamental terms and aspects of the chemical education have been introduced. We have been looking at the single atom and its components such as the nucleus (protons and neutrons) and the surrounding electrons. The challenge in describing the motion of the electrons relative to the atomic nucleus has been introduced by use of different theories and models. These theories and models all aim in the ability to explain the different lines in the line spectra for the different elements. The atomic model derived by the Danish scientist Niels Bohr is presented and after that quantum mechanical considerations led to the viewing of electrons in motion either as particles in motion or as electromagnetic waves. From that the description of the atomic orbitals emerged. These orbitals can be visualized as areas around the nucleus with largest possibility of finding the electrons that are hosted in the orbitals. With these orbitals as a launching pad, the so-called *aufbau principle* is presented. The orbitals with the lowest energy level will be “filled” with electrons first and this leads to the construction of the periodic table. Thus the electron configurations of the elements are closely related to the construction of the periodic table. A categorization of the elements as metals, half-metals or non-metals is also given and examples of different periodic tendencies are given related to different term such as atomic radius, ionization energy, electronegativity and electron affinity.

In the next chapter we will move from the single atom to the chemical components which consist of more than one atom. We are going to look at chemical bonds and molecules.

2. Chemical compounds

In chapter 1 we saw how the elements (single atoms) are arranged in the periodic table according to in which orbitals their valence electrons are hosted. The single orbitals have been described as well. In this chapter we will among other factors use our knowledge about atomic orbitals to answer the following question:

Why do two hydrogen atoms join and form a H_2 molecule when for example two helium atoms rather prefer to stay separate than to form a He_2 molecule?

We are also going to look at the geometry of different molecules by using orbital theory. That way we can among other factors find the answer to the following question:

Why are the atoms in a CO_2 molecule placed in a straight line (linear molecule) when the atoms in a H_2O molecule are placed in an angle (V-shape)?

When we have been looking at different molecules we are going to move into the field of metals. In metals the atoms are arranged in lattice structures. By looking at these different lattice structures it will then be clear why metals have such high electrical conductance in all directions. We will also look at structures in solid ionic compounds like common salt which have great similarities with the metallic structures.

2.1 Bonds and forces

Initially it is a good idea to introduce the different types of bonds that hold atoms together in molecules (intramolecular forces), metal lattices and ionic lattices. After that we are going to look at which types of forces that interacts between molecules (intermolecular forces).

2.1.1 Bond types

Chemical bonds consist in that electrons from the different atoms interact and thus bind the atoms together. There are three types of chemical bonds that we are going to deal with in this book.

Covalent bonds

Ionic bonds

Metal bonds

A *covalent bond* consists in that two atoms share an electron pair. Each atom supplies one electron to this electron pair. When we are dealing with two atom of the same element we have a pure covalent bond. If the two atoms are not the same the most electronegative atom (see section 1.2.4 *Periodic tendencies*) will attract the electron pair more than the less electronegative atom. Thus the electron density around the most electronegative atom will be larger than the electron density around the less electronegative atom. In this

case the covalent bond can be considered as a so-called *polar covalent bond*. When the difference in electronegativity between the two atom reaches a certain level, the electron pair will almost exclusively be present around the most electronegative atom which will then be an anion. The less electronegative atom will then be a cation since it has almost completely “lost” its bonding electron. This type of bond is called an *ionic bond* and it can be considered as consisting of electrostatic interactions between a cation and an anion rather than the sharing an electron pair. The transition from pure covalent bond over polar covalent bond to ionic bond is thus fluent which is sketched in Figure 2- 1.

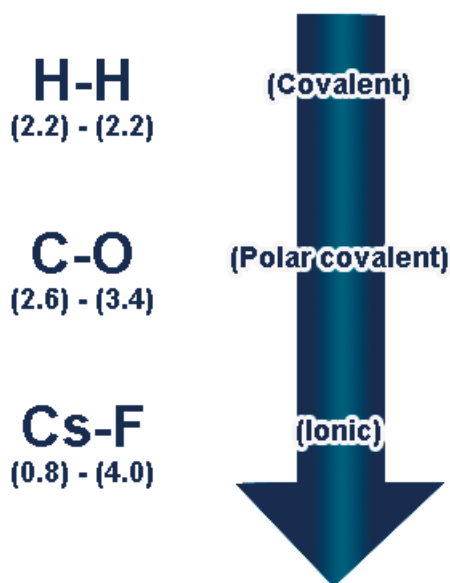

Figure 2- 1: From covalent to ionic bonds

The transition from covalent to ionic bonds is fluent and depends on the difference between the electronegativity of the atoms. The electronegativities are given in parenthesis below the sketched examples of bonds.

You have metal bonds when the metal atoms are placed in a three-dimensional lattice. In such a lattice the bond electrons “flow” around in all directions in the lattice which results in a very high electrical conductance in all directions. We have now been talking a little bit about *intramolecular* forces. The different bond types will be described in the following sections but first we are going to look at the *intermolecular* forces that interact *between* the molecules and not *inside* molecules.

2.1.2 Intermolecular forces

It is very important not to confuse the two terms *intramolecular forces* and *intermolecular forces*. Intramolecular forces are forces that act *inside* the molecules and thus constitute the bonds between the atoms. Intermolecular forces on the other hand are forces that act *outside* the molecules between molecules. The energies of chemical bonds (intramolecular forces) are much larger than the energies related to the intermolecular forces. Three different types of intermolecular forces can be distinguished:

- Dipole - dipole forces
 - Hydrogen bonds
 - London forces
- } Intermolecular forces

Intermolecular forces to a more or minor extent hold the molecules together. If the intermolecular forces did not exist, all molecular components would be gasses. In a molecule consisting of two different atoms the bond electron pair will by average be present most around the atom with the highest electronegativity as we saw in the section *2.1.1 Bond types*. Thus we have a polar covalent or ionic bond and the molecules have a dipole moment which leads to the existence of dipole-dipole forces acting between the molecules. This will be exemplified in the following example.

WHAT'S MISSING IN THIS EQUATION?

You could be one of our future talents

MAERSK INTERNATIONAL TECHNOLOGY & SCIENCE PROGRAMME

Are you about to graduate as an **engineer** or **geoscientist**? Or have you already graduated?
If so, there may be an exciting future for you with A.P. Moller - Maersk.



MAERSK

www.maersk.com/mitas

Please click the advert

Example 2- A:*Dipole-dipole forces among HCl molecules*

In Figure 2- 2 the dipole-dipole forces acting between hydrogen chloride molecules in the gas state are sketched.

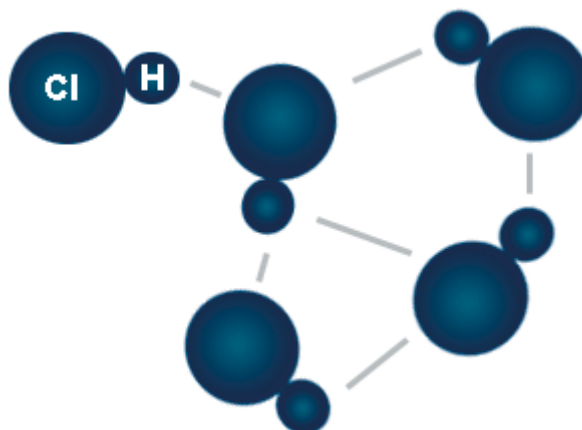
**Figure 2- 2: Dipole-dipole forces among HCl molecules**

The bond electron pair will by average be located most of the time closest to the chlorine atom because of the larger electronegativity. Thus the chlorine atom in the molecule constitutes a negative pole while the hydrogen atom constitutes the positive pole. Dipole-dipole interactions among the molecules are sketched by the grey lines.

The dipole-dipole forces act between the molecules because the negative end of one molecule will attract the positive end of another molecule. The dipole-dipole forces can comprise up to 1 % of the forces that act between to atoms in a covalent bond. Thus the intermolecular dipole-dipole forces are very week compared to the intramolecular covalent forces.

Hydrogen bonds are a special strong kind of dipole-dipole force. Actually hydrogen bonds are by fare the strongest kind of intermolecular forces. A hydrogen bond can comprise up to almost 20 % of the forces that exist between two atoms in a covalent bond. Hydrogen bonds can exist in the following contexts:

From an H-atom to an N-atom in the neighbour molecule

From an H-atom to an O-atom in the neighbour molecule

From an H-atom to an F-atom in the neighbour molecule

The hydrogen atom in the hydrogen bond constitutes the positive pole while the N, O or F-molecule constitutes the negative pole. In the following example we are going to look more at hydrogen bonds.

Example 2- B*Hydrogen bonds between water molecules*

Hydrogen bonds play a great role in water. In Figure 2- 3 hydrogen bonds between water molecules are sketched.

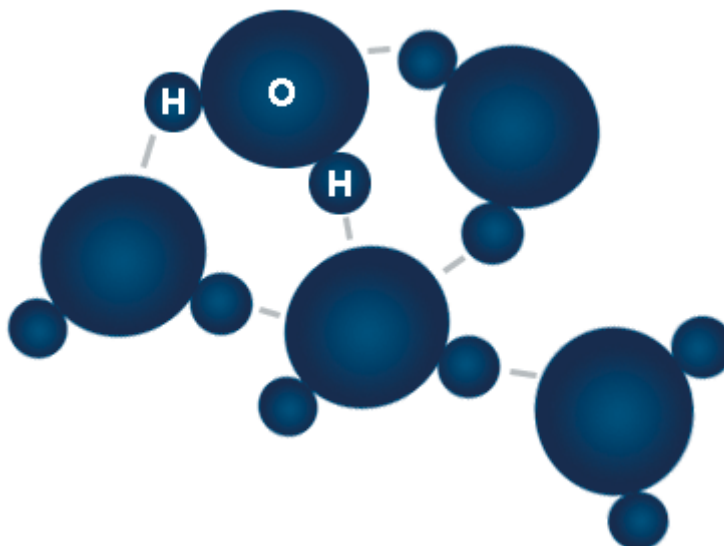
**Figure 2- 3: Hydrogen bonds between water molecules**

Hydrogen bonds between hydrogen atoms and oxygen atoms in neighbour molecule are sketched by the grey lines.

It is the hydrogen bonds in water that gives the relative large boiling point of water. Hydrogen bonds can comprise the energy amount of almost 20 % of a covalent bond.

Hydrogen bonds also have great biological importance since they among other factors contribute to the maintenance of the helical structure of DNA-molecules.

London forces are named after the German-born scientist Fritz London. London forces are a type of forces that exists among *all* kinds of molecules. While dipole-dipole forces only acts between molecules with dipole moments and hydrogen bonds only acts between molecules containing hydrogen and either nitrogen, oxygen or fluor, London forces act between *all* kinds of molecules. It is the London forces that bind molecules which on the outside appears unpolar (no dipole moment) together. The electron cloud that surrounds an atom or a molecule with no dipole moment will on an average be equally distributed around the whole atom or molecule. But if you look at the electron cloud at a specific time, the electron cloud will be displaced. You can say that the electron cloud “laps” around the atom or molecule like waves at the oceans thus inducing momentarily dipole moments. These momentary dipole moments can momentary interact with the momentary dipole moment in the neighbour molecule. These interactions are called London forces and in the following example we are going to look at the London forces that act between hydrogen molecules.

Example 2- C:*London forces between hydrogen molecules*

Hydrogen molecules on the outside have no dipole moments. Even so some forces act between the hydrogen molecules. These forces are the London forces and they exist because the electron clouds in the hydrogen molecules “laps” around and induce momentary dipole moments that momentary can interact with each other and thus “drag” the molecules together. This is sketched in Figure 2- 4.

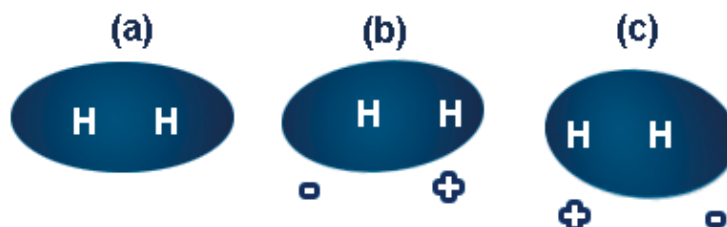
**Figure 2- 4: London forces between hydrogen molecules**

(a) By average the electron cloud is located equally around the H-H bond. Thus by average there is no dipole moment. (b) At a given time the electron cloud will be displaced so that that there will be a momentary dipole moment. (c) At another given time the electron cloud will be displaced in another way so that a “new” dipole moment will be induced. Interactions between momentary dipole moments are called London forces.

The more electrons that are present in the molecule the more electrons can “lap” around and the larger momentary dipole moments can be induced. Therefore London forces are larger between larger molecules.

www.job.oticon.dk

oticon
PEOPLE FIRST

Till now in this chapter we have very briefly been looking at the different types of bonds that can exist between two atoms (intramolecular forces) and at the different types of forces that can act between molecules (intermolecular forces). In the following sections we are going to look more detailed into the different types of chemical bonds. That way we among other aspects will be able to explain why it is beneficial for some atoms to join in a chemical bond and why this is not the case for other atoms.

2.2 Covalent bonds

In this section we are going to look at the nature of the covalent bonds.

Why do covalent bonds form?

Which structures do molecules with covalent bonds presume?

These questions and other aspects concerning energy considerations, molecular orbital theory, Lewis structures, VSEPR theory and orbital hybridization theory will be answered and covered in this section.

2.2.1 Energy considerations

When two atoms join and form a molecule by creating a covalent bond, it always happens because in terms of energy it is favourable. The total energy can be lowered by creating the covalent bond and this is the reason that the bond is formed.

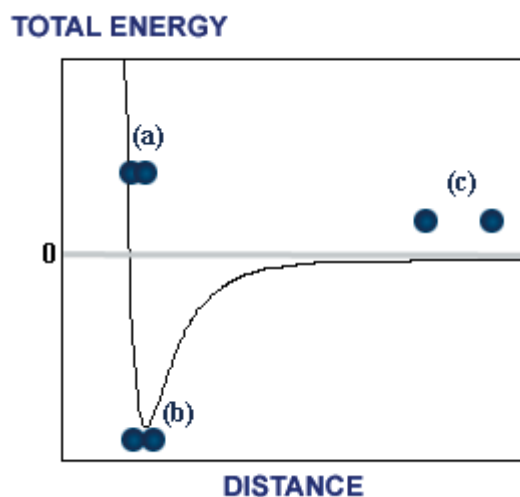

Figure 2- 5: Energy profile

The total energy between two hydrogen atoms as a function of their distance. (a) When the two hydrogen atoms are force close together the potential energy increases very dramatic similar to when two north pole magnets are forced together. (b) At a certain distance (which is the bond length) between the two hydrogen atoms there is a minimum in energy. (c) When the two hydrogen atoms are fare away from each other the energy is zero which corresponds to no bonding.

In the graph on Figure 2- 5 it is seen that at a certain distance between the two atomic nuclei the total energy has a minimum. This distance corresponds to the bond length of the covalent bond between the atoms. When the two atoms are far apart from each other the total energy is zero which corresponds to the existence of no bond at all. If the two atoms are forced together (closer together than the bond length), the total energy will increase dramatically and the atoms will repel each other. This can be compared to when two north pole (or south pole) magnets are forced together. The potential energy will increase very much and they will repel each other.

2.2.2 Molecular orbital theory

The energy profile in Figure 2- 5 shows that at a certain distance between the atoms there is a minimum in energy which just corresponds to the bond length of the covalent bond. However we still know nothing about how and where the two electrons of the bonding electron pair are placed. It is also seen in Figure 2- 5 when going from the right to the left that when two atoms approach each other the energy will be minimized when approaching the bond length. How can this be explained? *Molecular orbital theory* can be used to explain why some atoms form molecules and why others do not¹.

When two atoms approach each other the atomic orbitals will "melt" together and new so-called *molecular orbitals* will be formed. In these molecular orbitals the bond electrons of the covalent bond will be hosted. There are two types of molecular orbitals:

Bond orbitals, denoted with the Greek letter σ

Anti-bond orbitals, denoted with σ^*

The bond orbitals have lower energy levels compared to the anti-bond orbitals. As for the atomic orbitals these molecular orbitals are each able to host two electrons. In the following example we are going to see how the atomic orbitals of two hydrogen atoms "melt" together and form two molecular orbitals during the formation of a hydrogen molecule.

¹ When we are talking about orbitals (as in chapter 1) it is initially important to notice that we are talking about mathematical models that are able to explain different physical and chemical phenomena. It is not necessarily evidenced that the actual physical and chemical conditions are in agreement with the models but the models are just efficient in explaining certain behaviors, tendencies and conditions.

Example 2- D:*Molecular orbitals in the hydrogen molecule*

The hydrogen molecule is here used as an example since it is relatively simple because the number of electrons is only 2 in total. Each (valence) electron of the hydrogen atoms is hosted in a 1s-orbital when the two atoms are single. When the two 1s-orbitals approach each other, two new molecular orbitals are formed; one bond orbital and one anti-bond orbital which is sketched in Figure 2- 6.

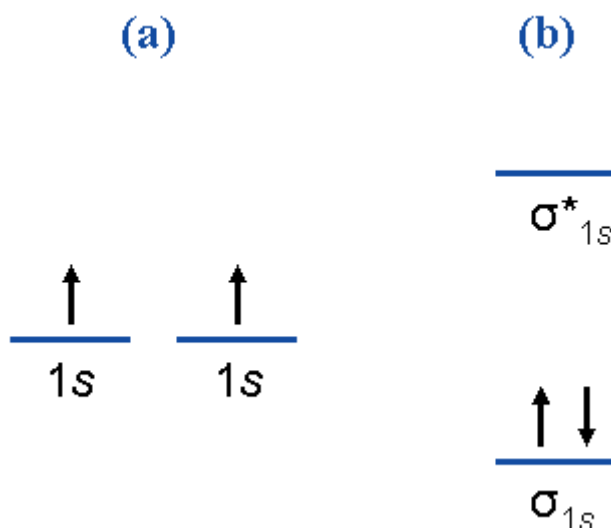
**Figure 2- 6: Molecular orbitals in the hydrogen molecule**

(a) The two atomic orbitals (1s) when the atoms appear in single (b) The two atomic orbitals “melt” together and two molecular orbitals are created. One of the molecular orbitals is a bond orbital (σ_{1s}) and one is an anti-bond orbital (σ^*_{1s}).

Since the molecular bond orbital (σ_{1s}) is lower in energy level at the two individual atomic orbitals, the two valence electrons rather prefer so stay in the bond orbital. The energy level of the anti-bond orbital (σ^*_{1s}) is higher than that of the atomic orbitals and thus the valence electrons will no be hosted in this orbital.

So because the total energy can be minimized it is beneficial for the two hydrogen atoms to create a hydrogen molecule.

A covalent bond can be assigned with a so-called *bond order* according to the following equation:

$$\text{Bond order} = \frac{(\text{electrons in bond orbitals}) - (\text{electrons in anti-bond orbitals})}{2} \quad (2-1)$$

The bond order is related to the bond energy. The larger bond orders the larger bond energy. In the case with the hydrogen molecule (Figure 2- 6 on page 54) there are two electrons in the bond orbital σ_{1s} and zero electrons in the anti-bond orbital σ_{1s}^* . This gives the covalent H-H bond a bond order of 1 and it corresponds to a *single bond*. If the bond order would have been 2 (corresponding to a *double bond*) the bond energy would have been larger. In the following example we find out why two helium atoms do not join and form a helium molecule (He_2).

Please click the advert

CHALLENGE YOURSELF

WWW.STUDYINSWEDEN.SE

Si.
Swedish Institute

Today's job market values ambitious, innovative, perceptive team players. Swedish universities foster these qualities through a forward-thinking culture where you're close to the latest ideas and global trends.

Whatever your career goals may be, studying in Sweden will give you valuable skills and a competitive advantage for your future. www.studyinsweden.se

Download free books at BookBooN.com

Example 2- E:*Molecular orbitals in a “helium molecule”*

A helium atom has both of its valence electrons in the 1s-orbital. When two helium atoms approach each other two molecular orbital can be formed which is sketched in Figure 2- 7.

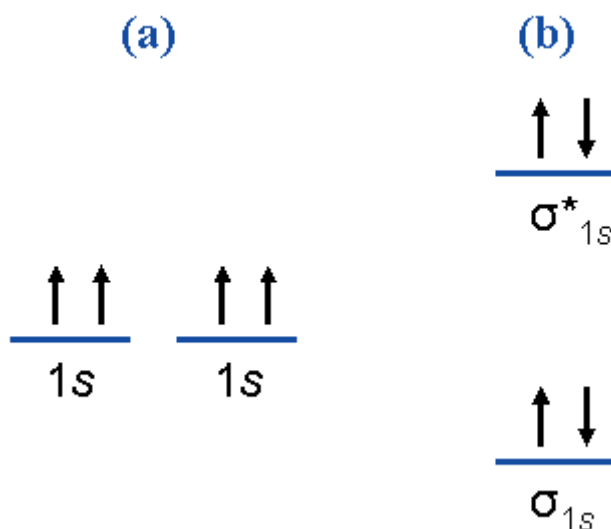
**Figure 2- 7: Molecular orbitals in a “helium molecule”**

(a) The two atomic orbitals (1s) when the atoms appear in single. (b) The two atomic orbitals “melt” together and two new molecular orbitals are created. One of the molecular orbitals is a bond orbital (σ_{1s}) and one is an anti-bond orbital (σ^*_{1s}) but no chemical bond is created since the bond order is zero.

Since only two electrons can be hosted in each orbital, the total number of four valence electrons has to be distributed into two electrons in the bond orbital and two electrons into the anti-bond orbital. The bond order is then calculated by use of equation (2- 1) from page 55:

$$\text{Bond order} = \frac{2-2}{2} = 0$$

This situation gives a bond order of zero according to equation (2- 1) and thus it is not beneficial for two helium atoms to join and form a covalent bond. This is hence the answer to the question about why two hydrogen atoms form a molecule while two helium atoms do not.

When talking about molecular orbital theory you have to be aware of the following:

It is only the atomic orbitals of the valence electrons that are transformed into molecular orbitals.

The total number of valence electron atomic orbitals equals the number of molecular orbitals.

For two identical atoms: Molecular orbitals are denoted σ (bond orbital) and σ^* (anti-bond orbital)

respectively followed by the name of the former atomic orbitals (see for example Figure 2- 6 on page 54 and Figure 2- 7 on page 56)

It can be quite a difficult task to find out which molecular orbitals that are formed and which energy levels these orbital have when we are looking at other atoms than hydrogen and helium; especially when we are dealing with different atoms with different numbers of valence electrons in different types of atomic orbitals. In this book we are not going to go more into molecular orbital theory. This was just a brief introduction to a model which could explain why some atoms form molecules and why other atoms do not. It is all a matter of bond orders. If the bond order is zero there is no benefit in terms of energy of forming a molecule. If the bond order is larger than zero it is beneficial in terms of energy to form a molecule.

Molecular orbital theory can also be used to explain other phenomena such as diamagnetism and paramagnetism. According to Hund's rule (see section 1.2.2 *Electron configuration*) the electrons would rather prefer to stay unpaired in the atomic orbitals if this is possible. This is also the case in the molecular orbitals. If it is possible for the electrons to stay unpaired in the molecular orbitals they will do so and the molecules will appear paramagnetic. This is for example the case with the oxygen molecule (O_2) which has two unpaired electrons in two of the anti-bond orbitals.

Please click the advert

Always aiming for higher ground. Just another day at the office for a Tiger.

Join the Accenture High Performance Business Forum

On Thursday, April 23rd, Accenture invites top students to the High Performance Business Forum where you can learn how leading Danish companies are using the current economic downturn to gain competitive advantages. You will meet two of Accenture's global senior executives as they present new original research and illustrate how technology can help forward thinking companies cope with the downturn.

Visit student.accentureforum.dk to see the program and register

Visit student.accentureforum.dk

• Consulting • Technology • Outsourcing

accenture
High performance. Delivered.

© 2009 Accenture. All rights reserved.

2.2.3 Lewis structure

In section 2.2.2 *Molecular orbital theory* we saw among other things that bond orders can be explained from molecular orbital theory. In this section we are going to look at another theory that can explain bond orders as well as helping us to determine the position of the atoms inside molecule relative to each other. We are going to spend some time on the Lewis theory which is named after the American scientist G. N. Lewis. According to Lewis' theory the atoms have one goal when they join and form molecules:

The goal of the atoms during the formation of molecules is to get the valence electron orbital filled up with electron (Lewis' theory)

For a while let us forget all about molecular orbital theory and think in terms of atomic orbitals. When atoms join and form molecules they will seek to get their valence electron orbitals filled with electrons according to the theory of G.N. Lewis. This implies the following:

Hydrogen pursues to be surrounded by 2 electrons so that the valence electron atomic orbital $1s$ will be filled up with electrons.

Elements in the 2nd period pursue to be surrounded by 8 electrons so that the valence electron atomic orbitals ($2s$ and $3 \times 2p$) will be filled up with electrons. This is referred to as the *octet rule* since "octa" means "eight".

The atoms can obtain this by sharing electrons. The elements in the 3rd period and downwards have the ability of being surrounded by more than eight electrons since their empty 3d-atomic orbitals can assist in hosting the shared electron pairs. When you want to determine the bond order in a molecule, the molecule with all its atoms can be written in so-called *dot form*. This is done by writing the letter symbol of the atom surrounded by a number of dots corresponding to the number of valence electrons for that particular atom. The atoms in dot forms can then be combined into *Lewis structures* for different molecules. First we are going to write different atoms in "dot form" in the following example.

Example 2- F:*Atoms in "dot notation"*

In Figure 2- 8 different atoms are given in *electron dot form*. First the number of valence electrons is determined from the position in the periodic table. Then a number of dots are placed around the letter symbol for the atom corresponding to the number of valence electrons. We have to notice that it is *only* the valence electrons that are represented by dots.

**Figure 2- 8: Atoms in "dot notation"**

The hydrogen atom has one valence electron, the helium atom has two valence electrons, the silicon atom has four valence electrons and the argon atom has eight valence electrons (the octet rule is fulfilled for argon).

The number of dots corresponds to the number of valence electrons in the particular atom. When the atom is surrounded by eight electrons the octet rule is satisfied. The electrons are often placed in pairs. Such an electron pair is called a *lone pair*.

By use of Lewis' theory and atoms in "electron dot forms" we are prepared to look at how atoms are arranged inside the molecules relative to each other. When the so-called *Lewis structure* of a molecule or composite ion is to be written down, the following guidelines have to be followed:

Determine the total number of valence electrons for the molecule/composite ion. This is done by summing up the number of valence electrons for the individual atoms (plus the eventual "extra ionic charge" if we are dealing with a composite ion). Thus the number of "dots" of the individual atoms has to be counted.

(2- 2)

Connect all atoms by using one electron pair.

Arrange the remaining valence electrons such that hydrogen atoms are surrounded by 2 atoms and that the octet rule is satisfied for the elements from the 2nd period. It can be necessary to let more than one electron pair be a part of chemical bond (creation of double or triple bonds).

In the following examples we are going to write down the Lewis structures for different molecules and composite ions by using these three steps given in (2- 2).

Example 2- G:

The ammonia molecule in Lewis structure

An ammonia molecule consists of three hydrogen atoms and one nitrogen atom. How are these atoms placed relative to each other? In order to answer this question we will write down the Lewis structure according to the guidelines given in (2- 2) on page 59.

Number of valence electrons = 5 (from nitrogen) + 3 × 1 (from hydrogen) = 8

Use one electron pair to connect each N-H atom pair

The last $8 - 3 \times 2 = 2$ electrons are arranged so that the octet rule is satisfied

These three steps are sketched in Figure 2- 9.

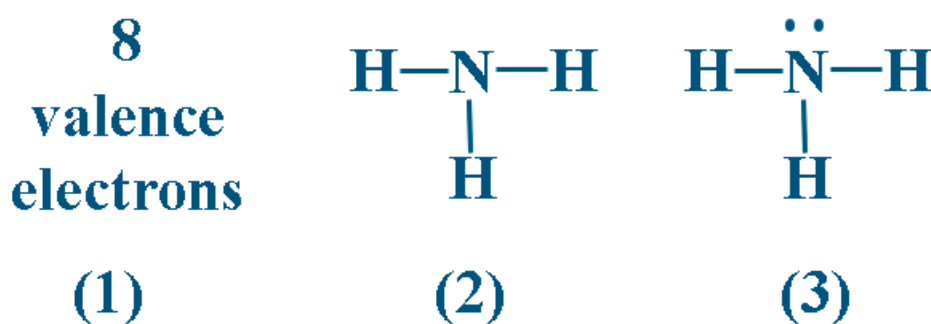

Figure 2- 9: Lewis structure for the ammonia molecule

The three steps in writing the Lewis structure. The octet rule has to be satisfied for all the atoms in the molecule. Thus the lone pair is placed on the nitrogen atom.

The only way in which the octet rule can be satisfied is by placing the atoms and electrons as sketched in the figure. Moreover it is seen that the three N-H bonds consist of single electron pairs which corresponds to single bonds. The Lewis structure has thus told us that in an ammonia molecule the nitrogen atom is placed in the centre connected to each of the three hydrogen atoms by single bonds. Further more a lone pair is “attached” to the nitrogen atom. We now know something about the internal arrangement of atoms and lone pairs inside the molecule but we do not know about the actual geometry of the molecule.

In an ammonia molecule all bonds are single bonds. Sometime in order to satisfy the octet rule when Lewis structures are to be written down for certain molecules it is necessary to let more than one electron pair go into a bond. This leads to a higher bond order than 1. We are going to look at such a case for a molecule of carbon dioxide.

Example 2- H:

The carbon dioxide molecule in Lewis structure

A molecule of carbon dioxide consists of a carbon atom and two oxygen atoms. We wish to write down the Lewis structure for this molecule in order to investigate the bond orders of the bonds inside the molecule. Thus we again follow the guidelines given in (2- 2) on page 59.

Number of valence electrons = 4 (from carbon) + 2 × 6 (from oxygen) = 16

Use one electron pair to connect each C-O bond

Arrange the last 16 - 2×2 = 12 electrons so that the octet rule is satisfied for all three atoms

The octet rule can only be satisfied if each C-O bond is made of two electron pairs which equals to four electrons. This corresponds to double bonds. The three steps are sketched in Figure 2- 10.

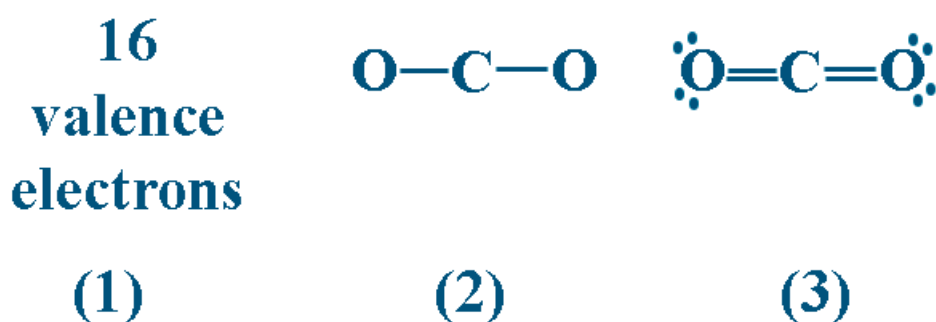

Figure 2- 10: Lewis structure for the carbon dioxide molecule

The three steps in writing the Lewis structure. The octet rule has to be satisfied for all the atoms in the molecule. Therefore it is necessary with double bonds between the carbon atom and the oxygen atoms.

That way the Lewis structure for carbon dioxide has now told us that in this molecule the carbon atom is placed in the centre. Each oxygen atom is double bonded to the carbon atom and two lone pairs are “attached” to each oxygen atom. But from the Lewis structure we know nothing about the actual molecular geometry.

We know that hydrogen (from the 1st period) pursues to be surrounded by *two* electrons and that elements from the 2nd period pursues satisfy the octet rule by being surrounded by *eight* electrons. The elements from the 3rd period and downwards can however be surrounded by more than eight atoms because their empty d-orbitals are able to assist in hosting more than the eight electrons. We are going to look more at such a case for a molecule of sulphur hexafluoride for which we are going to write the Lewis structure.

Example 2- 1:

The sulphur hexafluoride molecule in Lewis structure

A SF₆ molecule consists of one sulphur atom and six fluor atoms. We wish to write down the Lewis structure for this molecule in order to know something about the internal atomic arrangement and the positions of the lone pairs in this molecule. Thus the 3-step procedure given by (2- 2) on page 59 is used again:

Number of valence electrons = 6 (from sulphur) + 6×7 (from fluor) = 48

Use one electron pair pr. S-F bond. Since sulphur is from the 3rd period it can be surrounded by more than eight electrons.

The remaining 48 - 6×2 = 36 electrons are arranged so that the octet rule is satisfied for all fluor atoms.

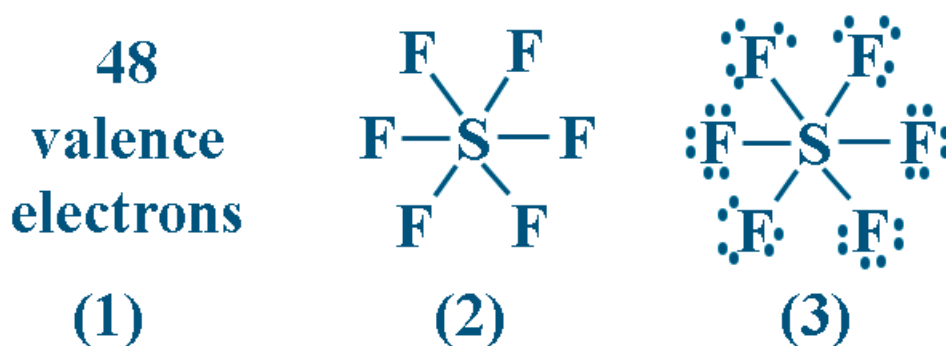

Figure 2- 11: Lewis structure for the sulphur hexafluoride molecule

The three steps in writing the Lewis structure. The octet rule has to be satisfied for all the atoms in the molecule. Sulphur from the 3rd period has the ability to be surrounded by more than eight electrons pairs by using its empty 3d-orbitals.

From the Lewis structure we now know that the sulphur atom is placed in the centre and is bonded to the six fluor atoms by single bonds. Furthermore we know that each fluor atom is surrounded by three lone pairs. But from the Lewis structure we know nothing about the actual geometry of the molecule.

The 3-step procedure given by (2- 2) on page 59 can also be applied for composite ions such as sulphate, nitrate, cyanide etc. We are going to look more into that in the following example where the Lewis structure for nitrate will be written down. During this procedure we will run into the concept of *resonance structures*.

Example 2- J:*Nitrat in Lewis structure*

Nitrate (NO_3^-) consists of a nitrogen atom, three oxygen atoms plus one negative charge. We wish to write down the Lewis structure for this composite ion. Thus we use the three steps given by (2- 2) on page 59.

Number of valence electrons = 5 (from nitrogen) + 3×6 (from oxygen) + 1 (one extra negative charge) = 24

Use one electron pair pr. N-O bond.

The remaining $24 - 3 \times 2 = 18$ electrons are arranged so that the octet rule will be satisfied for all atoms.

Here it is necessary to let one of the N-O bonds be a double bond. Experiments have however proved that the bond energy for the three N-O bonds is equal which indicated that all three N-O bonds are similar.

Thus you consider the Lewis structure for nitrate to be a mixture of the three structures given in Figure 2- 12(3). These three possible Lewis structures given in Figure 2- 12(3) are called *resonance structures*.

Alternatively the bonds can be sketched by one full line and one dotted line to show the case of resonance.

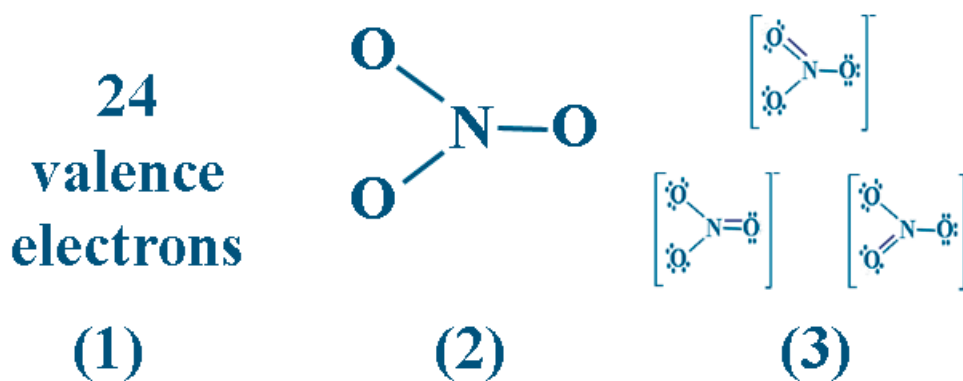

Figure 2- 12: Lewis structure for nitrate

The Lewis structure for nitrate is a combination of three resonance structures.

From the Lewis structure we now know that the structure of nitrate is given by three resonance structures. Furthermore we have information about the bond order (larger than 1 and less than 2) and placement of lone pairs. But we know nothing about the actual geometry of the composite ion.

In the examples we have been looking at till now in this section it has been pretty clear which atom would be the central atom. For some molecules or composite ions however it is not always so obvious which atom that is the central atom. In order to be able to write down the Lewis structure for such a molecule or composite ion, we have to introduce the concept of *formal charge*. The formal charge of an atom in a molecule or composite ion has the following definition:

$$\left. \begin{array}{l} \text{Formal charge} \\ \text{of an atom} \end{array} \right\} = (\text{number of surrounding electrons}) - (\text{number of valence electrons}) \quad (2-3)$$

The number of surrounding electrons is determined firstly by dividing the number of bond electrons equally between the two atoms among which the chemical bond is located. Secondly you count the number electrons surrounding the atom on the Lewis structure. The number of valence electrons for an element is known from its electron configuration and thus from its position in the periodic table. In the following example we are going to write down the Lewis structure for a dinitrogen oxide molecule and from the concept of formal charge we are going to evaluate which of more possible Lewis structures are the most realistic.

Please click the advert



it's an **interesting** world

Get under the skin of it.

Graduate opportunities
Cheltenham | £24,945 + benefits

One of the UK's intelligence services, GCHQ's role is two-fold: to gather and analyse intelligence which helps shape Britain's response to global events, and, to provide technical advice for the protection of Government communication and information systems. In doing so, our specialists – in IT, internet, engineering, languages, information assurance, mathematics and intelligence – get well beneath the surface of global affairs. If you thought the world was an interesting place, you really ought to explore our world of work.



www.careersinbritishintelligence.co.uk

Applicants must be British citizens. GCHQ values diversity and welcomes applicants from all sections of the community. We want our workforce to reflect the diversity of our work.

Example 2- K:*The dinitrogen oxid molecule in Lewis structure*

In the N_2O molecule it is not so obvious which of the atoms that should be the central atom and how the electrons shall be arranged in order to satisfy the octet rule for each atom. When the guidelines given in (2- 2) on page 59 are used you can reach the three Lewis structures given in Figure 2- 13a. In order to judge which of these three structures are the most realistic, the formal charge of each atom has to be determined according to (2- 3) on page 64. First the bond electrons are “shared” equally between the atoms as shown in Figure 2- 13b. The number of electrons surrounding each atom is counted. After that the number of valence electrons for that element is then drawn from the number of surrounding electrons and you then have the formal charge which is sketched in Figure 2- 13b. Since molecules normally seek to be as low in energy as possible, it is advantageous for them overall to be in as low formal charge as possible. Thus the most realistic of the Lewis structures given in Figure 2- 13a and b are the two upper ones. Thus the Lewis structure for the N_2O molecule can be considered as being a combination of the two structures given in Figure 2- 13c.

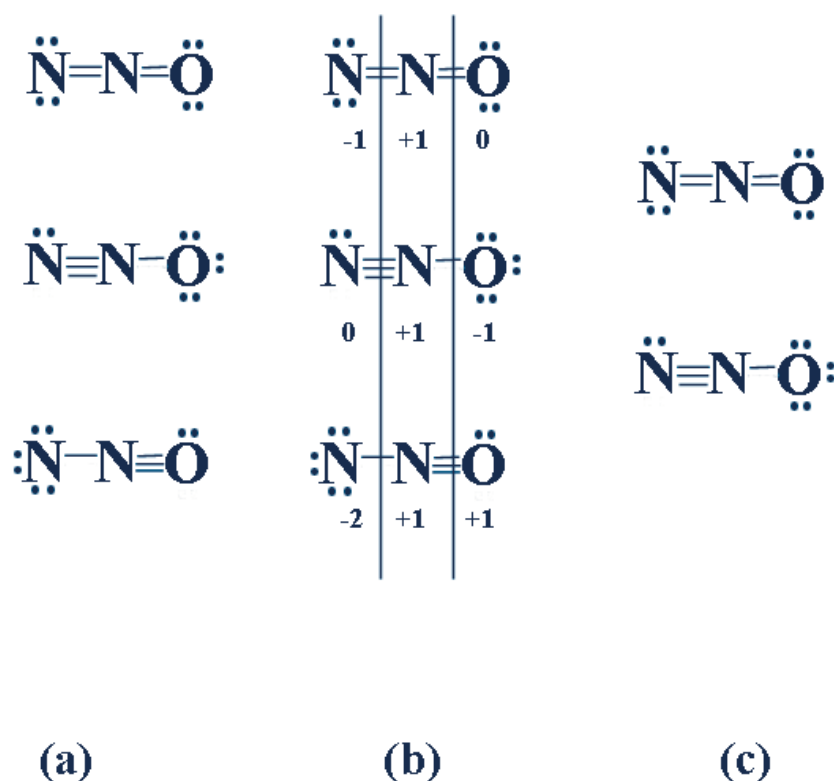
**Figure 2- 13 Lewis structure for the dinitrogen oxid molecule**

(a) Three possible Lewis structures. (b) The formal charge is determined for all three atoms in the molecule. (c) Lowest possible energy level is related with lowest possible formal charge for the single atoms. The first two structures are therefore more realistic than the last structure. The Lewis structure for the N_2O molecule is thus considered as a combination of the two upper structures.

It is seen in Figure 2- 13b that the formal charge is determined at the difference between number of surrounding electrons and valence electrons for a particular atom. A “half” single bond gives 1 surrounding electron pr. atom, a “half” double bond gives 2 surrounding electrons pr. atom and a “half” triple bond gives 3 surrounding electrons pr. atom. However from the Lewis structure we know nothing about the actual geometry of the molecule.

In the Lewis structure we now have a useful tool that can predict internal atomic arrangement and positions of lone pairs inside molecules and composite ions. Furthermore we can have valuable information about the bond orders (whether we are dealing with single, double or triple bonds) and we can get information about eventual resonance structures. The concept of formal charge could also be useful in judging which of more possible Lewis structures are the most realistic.

BUT the Lewis structures tell us nothing about the actual geometry of the molecules or composite ions.

Why is a carbon dioxide molecule linear?

Why is a water molecule V-shaped?

Why do ammonia molecules attain trigonal pyramid shape?

The answers to these questions can be found in the VSEPR theory which is the topic in the next section.

2.2.4 VSEPR theory

VSEPR stands for *valence shell electron pair repulsion*. VSEPR theory can be used to predict actual geometries of molecules and composite ions. To be more precise it is a matter of determining bond directions and angles from the central atom in a molecule or composite ion to the other atoms. VSEPR theory can very shortly be formulated as follows:

The electron groups surrounding the central atom in a molecule or composite ion will be located as far apart from each other as possible.

This statement or definition is based on an uncountable number of experimental studies of a numerous number of different molecules and composite ions during the times. A relevant question is now what an electron group really is? The answer to this is that an electron group can be the following:

- A single bond (one electron pair consisting of 2 electrons)
 - A double bond (two electron pairs consisting of 4 electrons)
 - A triple bond (three electron pairs consisting of 6 electrons)
 - A lone pair (one “free” electron pair consisting of 2 electrons)
 - A single electron (a radical)
- } different types of electron groups

When we are to determine how many electron groups that surround an atom, the Lewis structure can be of great help (see the previous section 2.2.3 *Lewis structure*). From the Lewis structure of a given molecule you can simply count how many bonds and lone pairs that surround an atom. That way you have the number of electron groups. The VSEPR theory tells us that these electron groups will be placed as far apart as possible. In the following example we will use the VSEPR theory to predict the molecular geometries of a water molecule and a carbon dioxide molecule. That way we will discover why a carbon dioxide molecule is linear and why a water molecule is V-shaped.

Please click the advert

CHALLENGE YOURSELF

WWW.STUDYINSWEDEN.SE

Today's job market values ambitious, innovative, perceptive team players. Swedish universities foster these qualities through a forward-thinking culture where you're close to the latest ideas and global trends.

Si.
Swedish Institute

Whatever your career goals may be, studying in Sweden will give you valuable skills and a competitive advantage for your future. www.studyinsweden.se

Download free books at BookBooN.com

Example 2- L:*CO₂ and H₂O, VSEPR theory*

We wish to predict the molecular geometries of a water molecule and a carbon dioxide molecule respectively. The VSEPR theory is our tool to solve this job and it tells us that the electron groups surrounding the central atom will be placed as far apart as possible.

The first step is to write the Lewis structure for the two molecules in order to be able to just count the number of electron groups surrounding the central atom. This is done in Figure 2- 14.

**Figure 2- 14: Electron groups in H₂O and CO₂**

From the Lewis structure the number of electron groups surrounding the central atoms is counted. The oxygen atoms in the water molecule are surrounded by four electron groups (two lone pairs and two single bonds). The carbon atom in the carbon dioxide molecule is surrounded by two electron groups (two double bonds).

The carbon atom in CO₂ is surrounded by two electron groups (two double bonds) whereas the oxygen atom in H₂O is surrounded by four electron groups (two single bonds and two lone pairs). According to the VSEPR theory these electron groups will be placed as far apart as possible. When there are only two electron groups these will be as far apart when they are placed 180° apart on a straight line with the central atom in the middle. Thus the atoms will be placed on a straight line which gives the linear structure of the carbon dioxide molecule. The four electron groups in the water molecule are placed as far apart as possible when they are placed in a so-called tetrahedron with angles of 109.5°. That way the two hydrogen atoms will be placed on two of the positions of the tetrahedron while the two lone pairs will occupy the two other positions. Thus the H-O-H bonds do not give a straight line but rather a V-shape. The angle of the H-O-H bonds is however slightly smaller than the tetrahedral angles of 109.5°. The H-O-H angle is actually just 104°. Thus an addition to the VSEPR theory is necessary in order to explain this “smaller” angle:

Lone pairs occupy a larger volume around the central atom than bond electron pairs. Thus lone pairs will “press” the atomic bond together.

This means that the two lone pairs around the oxygen atom in the water molecule will “press” the two single bonds together and therefore the H-O-H angle is smaller than the tetrahedral angle of 109.5°. The two geometries are sketched in Figure 2- 15.

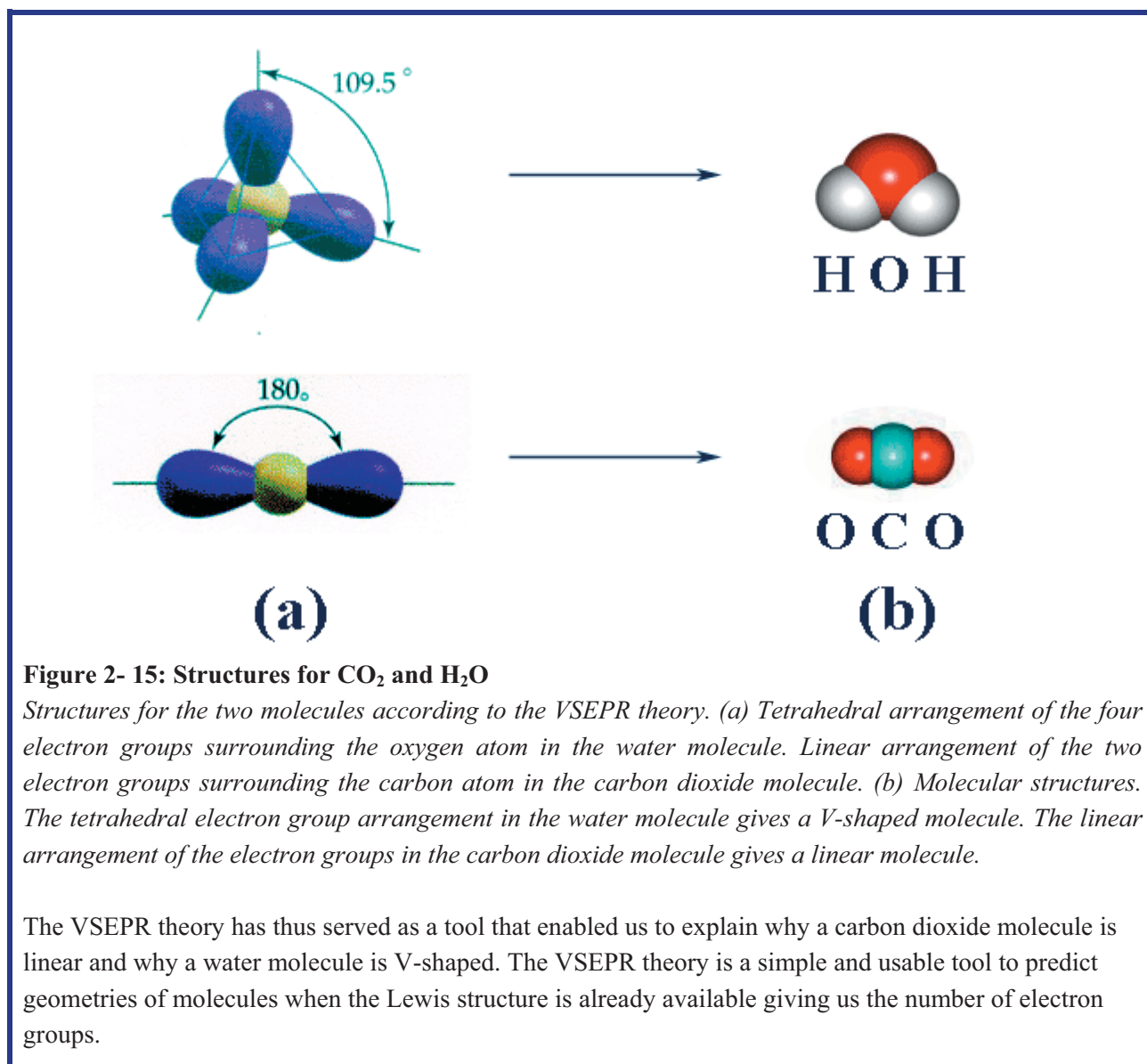

It is (as mentioned earlier) the number of electron groups surrounding the central atom that determines the arrangement and geometry around the central atom. In Example 2- L we just saw that lone pairs occupy more space than bond electrons. For lone pairs the following rules apply:

Lone pairs occupy more space than bond electron groups

Lone pairs will be placed as far apart from other lone pairs as possible

Lone pairs will be placed as far apart from bond electron groups as possible

These guidelines can be used to predict the arrangement of bond electron groups and lone pairs relative to each other around the central atom when the total number of electron groups is known and when the number of lone pairs is known. In Table 2- 1 you can see how the geometry of a molecule depends on the number of electron groups and how many of these groups that are lone pairs.

Table 2- 1: Geometries of molecules and composite ions

The geometry depends on the number of electron groups surrounding the central atom of the molecule or composite ions and how many of these electron groups that are lone pairs.

Electron groups	Electron group arrangement	Bond electron pairs	Lone pairs	Geometry of molecule or composite ion	Example
2	Linear	2	0	Linear	CO ₂
3	Trigonal planar	3	0	Trigonal planar	NO ₃ ⁻
		2	1	V-shape	NO ₂ ⁻
4	Tetrahedral	4	0	Tetrahedral	CH ₄
		3	1	Trigonal pyramidal	PH ₃
		2	2	V-shape	H ₂ O
5	Trigonal bipyramidal	5	0	Trigonal bipyramidal	PCl ₅
		4	1	Seesaw*	SF ₄
		3	2	T-shaped*	BrF ₃
		2	3	Linear	XeF ₂
6	Octahedral	6	0	Octahedral	SF ₆
		5	1	Square pyramidal	IF ₅
		4	2	Square planar	XeF ₄

*These rather special geometries are not explained in this book. Educational textbooks describing orbital hybridization theory can explain why these specific geometries are observed for the particular molecules for that particular number of bond electron groups and lone pairs.

By use of VSEPR theory, in which the Lewis structures helped us determining the number of surrounding electron groups, we are now able to predict actual structures of molecules and composite ions. However from the VSEPR theory we know nothing about the chemical bond itself. Where are the bond electrons actually placed? Or more specific: In which types of orbitals are the bond electrons placed? The answer to this can be found in the orbital hybridization theory which is the topic in the next section.

2.2.5 Orbital hybridization

In the previous section (2.2.4 VSEPR theory) we saw that the number of electron groups (bond electron pairs and lone pairs) around the central atom is determining the geometry of the molecule or composite ion. We have also been looking at the geometry of the atomic orbitals in the section 1.1.7 Orbital configuration.

However the orientations of the atomic orbitals in space do not fit the directions predicted by the VSEPR theory according to Table 2- 1 on page 70. For this reason other orbitals than the atomic orbitals must be present in the molecules and composite ions in order to “give” the right bond directions according to the VSEPR theory. These orbitals are a type of molecular orbitals (also mentioned in section 2.2.2 *Molecular orbital theory*) which are called *hybrid orbitals*. These hybrid orbitals thus host the valence electrons which constitutes the chemical bond between the atoms.

When atoms join and form molecules by creating covalent bonds, the atomic orbitals do not have the right directions and orientations which mean that they can not host the bond electrons. According to the theory of orbital hybridization the atoms solve this problem by making existing atomic orbitals into “new” hybrid orbitals. This is the same principle as for the molecular orbitals. These hybrid orbitals (which are molecular orbitals) then have the right orientation in space according the VSEPR theory. Thus the bond electrons and the lone pairs (the electron groups) surrounding the central atom can be placed as far apart as possible. The formation of the hybrid orbitals will be explained and sketched through the following examples.

Please click the advert

An advertisement for SKF. The background is a blue-tinted image of a woman with long dark hair smiling, with a wind turbine blurred in the background. The text is overlaid on the image.

Brain power

By 2020, wind could provide one-tenth of our planet's electricity needs. Already today, SKF's innovative know-how is crucial to running a large proportion of the world's wind turbines.

Up to 25 % of the generating costs relate to maintenance. These can be reduced dramatically thanks to our systems for on-line condition monitoring and automatic lubrication. We help make it more economical to create cleaner, cheaper energy out of thin air.

By sharing our experience, expertise, and creativity, industries can boost performance beyond expectations. Therefore we need the best employees who can meet this challenge!

The Power of Knowledge Engineering

Plug into The Power of Knowledge Engineering.
Visit us at www.skf.com/knowledge



Download free books at BookBooN.com

Example 2- M:*NH₃ molecule, sp³-hybridization*

Let us start by looking at a molecule of ammonia. First the Lewis structure of the molecule is written (done in Figure 2- 16a). The central nitrogen atom is surrounded by four electron groups (three single bonds and a lone pair). The question is in which orbitals these electron groups are hosted? The spherical atomic s-orbital and the three atomic p-orbitals are not arranged around the nitrogen atom in a tetrahedron as the VSEPR theory requires. The nitrogen atom solves this problem by transforming the four atomic orbitals into four “new” identical hybrid orbitals. These four orbitals are called *sp³* hybrid orbitals and they are arranged in a tetrahedral manner around the nitrogen atom.

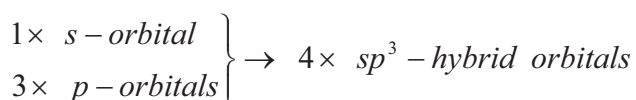

The name *sp³* indicates that we are talking about a transformation of *one* s-orbital and *three* p-orbitals. The new four hybrid orbitals are then used to host the four electron groups surrounding the nitrogen atom in the ammonia molecule which is sketched in Figure 2- 16b.

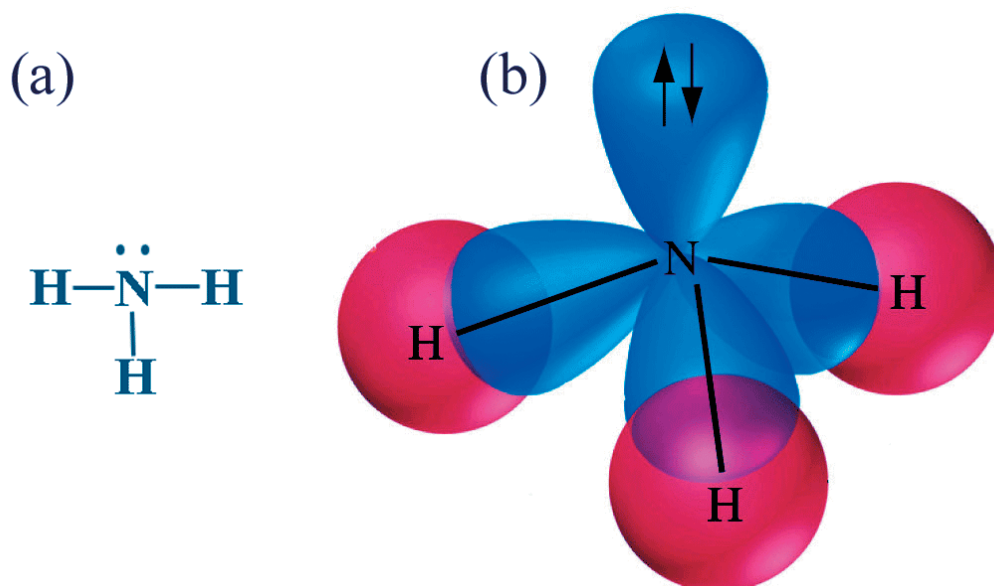

Figure 2- 16: *sp³*-hybridization in NH₃

(a) Lewis structure for the ammonia molecule. (b) The central nitrogen atom is *sp³* hybridized. The four *sp³* orbitals are blue on the figure. The 1s-orbitals of the three hydrogen atoms are red on the figure. The lone pair (marked with two arrows) occupies more space than the bond electron pairs between the nitrogen atom and the three hydrogen atoms. Thus the lone pair “pushes” the angles between the N and H atoms so that these angles become less than the tetrahedral angle of 109.5°.

By using the hybrid orbitals to host the bond electron pairs and the lone pair, the tetrahedral structure predicted by the VSEPR theory is obtained. You can see an overlap between the s-orbitals of the hydrogen

atoms and the sp^3 orbitals of the nitrogen atom and these overlaps constitute the single bonds. The lone pair occupies more space than the three bond electron pairs. This means that the lone pair “presses” the three bonds together so that the angles are only 107° rather than the tetrahedral angle of 109.5° .

Since only two electrons can be hosted in one orbital, the hybrid orbitals can only host one bond electron pair which correspond to the number of electrons in a single bond. Such a single bond is called an σ -bond which we also saw in the section 2.2.2 *Molecular orbital theory*. If we are dealing with a double bond (consisting of four electrons) one hybrid orbital is not enough for such a bond. In that case, already existing atomic p-orbitals are used for the creation of so-called π -bonds which together with σ -bonds constitute double bonds (and triple bonds). A molecule of ethene can be used as an example which we are going to look at now.

Trust and responsibility

NNE and Pharmaplan have joined forces to create NNE Pharmaplan, the world's leading engineering and consultancy company focused entirely on the pharma and biotech industries.

Inés Arízaga Esteva (Spain), 25 years old
Education: Chemical Engineer

– You have to be proactive and open-minded as a newcomer and make it clear to your colleagues what you are able to cope. The pharmaceutical field is new to me. But busy as they are, most of my colleagues find the time to teach me, and they also trust me. Even though it was a bit hard at first, I can feel over time that I am beginning to be taken seriously and that my contribution is appreciated.

Please click the advert



NNE Pharmaplan is the world's leading engineering and consultancy company focused entirely on the pharma and biotech industries. We employ more than 1500 people worldwide and offer global reach and local knowledge along with our all-encompassing list of services.
nnepharmaplan.com

nne pharmaplan®

Example 2- N:*C₂H₄ molecule, sp²-hybridization*

It is seen from the Lewis structure of C₂H₄ (Figure 2- 17a) that the two central carbon atoms each are surrounded by three electron groups (1 double bond and 2 single bonds). Three such electron groups surrounding the central atom results in a trigonal planar arrangement according to Table 2- 1 on page 70 (from the VSEPR theory). Thus there is a need for three identical orbital with such a trigonal planar arrangement to host the electron groups. Each carbon atom then transforms *one* s-orbital and *two* p-orbitals into three identical sp²-hybrid orbitals. As the name sp² indicated, they are “made” from *one* s-orbital and *two* p-orbitals.

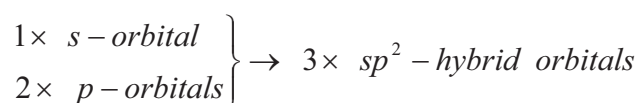

Hence *one* atomic p-orbital remains unchanged in each carbon atom. The double bond consists in that the overlap between two sp² orbitals constitutes an σ-bond while a π-bond is formed in the space between the two remaining atomic p-orbitals of the carbon atoms. This is sketched in Figure 2- 17b.

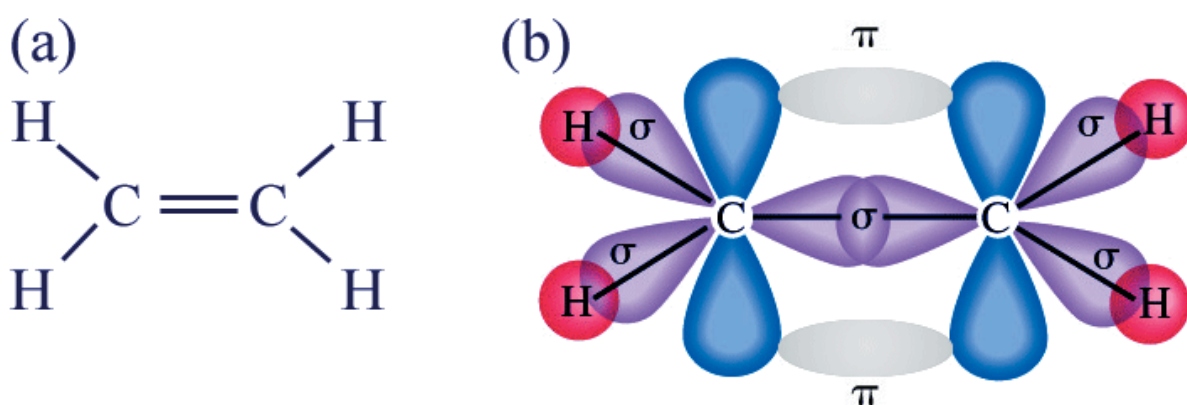
**Figure 2- 17: sp²-hybridization in C₂H₄**

(a) Lewis structure of an ethene molecule. (b) Each carbon atom is sp² hybridized (the 2×3 sp² orbitals are purple on the figure). The double bond consists of an σ-bond (overlap of the two sp² orbitals) and a π-bond in the space between the two p-atomic orbitals. The two p-orbital are blue on the figure while the π-bond is grey on the figure. The bonds to the hydrogen atoms are σ-bonds.

From the figure it is seen that rotation around the C=C double bond is not possible because the π-bond “locks” the possible of rotation. Thus double bonds are far less flexible compared to single bonds which only consist of σ-bonds.

In the previous example we have just seen how a double bond consists of *one* σ -bond and *one* π -bond. In the case with the linear carbon dioxide molecule, the central carbon atom is double bonded to each of the two oxygen atoms which we saw in Example 2- H on page 61. How is that possible? The answer is given in the following example.

Example 2- O:

CO₂ molecule, sp-hybridization

From the Lewis structure of the carbon dioxide molecule (Figure 2- 18a) it is seen that the carbon atom is surrounded by two electron groups (two double bonds). Two electron groups mean that there is a need for two identical orbitals 180° apart according to the VSEPR theory and Table 2- 1 on page 70. The carbon atom solves this problem by forming two identical so-called *sp*-hybrid orbital. As the name *sp* indicated these orbitals are made from *one* s-orbital and *one* p-orbital.

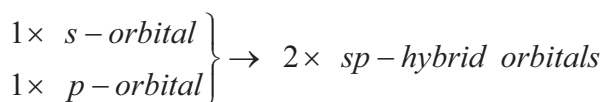

Hence *two* of the atomic p-orbitals in the carbon atom remain unchanged. From the Lewis structure it is also seen that each oxygen atom is surrounded by three electron groups (2 lone pairs and 1 double bond). In Example 2- N on page 74 we saw that three electron groups around an atom results in sp^2 hybridization. Thus the carbon atom is *sp*-hybridized and the two oxygen atoms are each sp^2 hybridized. This is sketched in Figure 2- 18b.

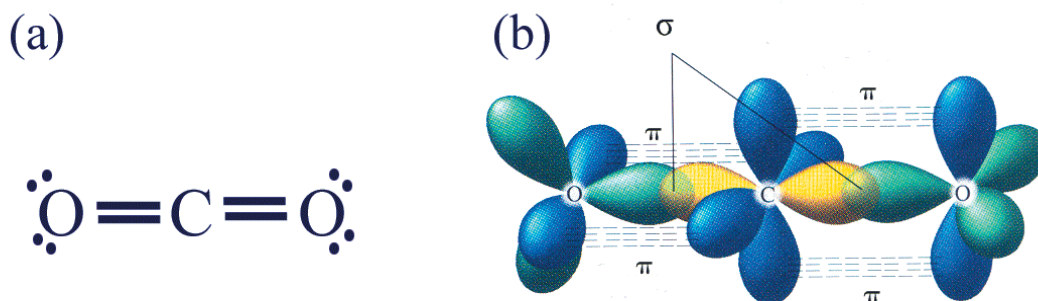

Figure 2- 18: sp-hybridization in CO₂

(a) Lewis structure of a carbon dioxide molecule. (b) The carbon atom is *sp*-hybridized (two yellow *sp*-orbitals) while the two oxygen atoms are sp^2 hybridized (2×3 green sp^2 -orbitals). The double bonds each consist of an σ -bond (overlap of a *sp*-orbital and a sp^2 -orbital) and a π -bond in the space between one p-orbital from the carbon atom and one from the oxygen atom. The p-orbitals are blue on the figure while the π -bonds are indicated with dotted lines.

Again we see that in double bonds we have σ -bonds in the overlap between hybrid orbitals and π -bonds in the space between atomic p-orbitals. Thus in the case of carbon dioxide the two π -bonds are rotated 90° relative to each other.

If the central atom is from the 3rd period and downwards we have seen (in the section 2.2.3 *Lewis structure*) that it is possible for the central atom to be surrounded by more than four electron groups (eight electrons). In Table 2- 1 on page 70 it is seen that when the central atom is surrounded by five electron groups these will be arranged as a trigonal bipyramide. This required five identical orbitals with such an arrangement and orientation. This is achieved if the central atom transforms five atomic orbitals (*one s-orbital, three p-orbitals and one d-orbital*) into *five* identical so-called dsp^3 -hybrid orbitals. Again the name indicates that these hybrid orbitals are made from *one s-orbital, three p-orbitals and one d-orbital*. In a similar manner we know that when the central atom is surrounded by six electron groups these will be arranged like an octahedron around the central atom. This requires *six* identically orbitals with such an arrangement and therefore the central atom transforms *one s-orbital, three p-orbitals and two d-orbitals* into *six* identically d^2sp^3 -hybrid orbitals which are arranged around the central atom like an octahedron.

Please click the advert

THE MILKWAY
LAUNCHING GRADUATE CAREERS

MILKROUND SYSTEM
Become a business star with internships, placements, graduate jobs & schemes from leading companies.
www.milkround.com

PLANET CAREER ADVICE
Inhabited by insights into business careers and orbited by application advice.

FIRST CONTACT
Get matched to top business employers via intelligent emails landing in your inbox.

Milkround.com: rated the #1 graduate recruitment website in the UK Graduate Careers Survey 2009 of 16,000 university finalists.

Milkround.com

Download free books at BookBooN.com

Table 2- 2: Hybrid orbitals

The number of electron groups surrounding the central atom determines which types of hybridization orbital that surround the central atom and thus the orbital geometry around the central atom.

Electron groups	Hybridization	Atomic Orbitals			Geometry around central atom
		s	p	d	
2	sp	1	1	0	Linear
3	sp^2	1	2	0	Trigonal planar
4	sp^3	1	3	0	Tetrahedral
5	dsp^3	1	3	1	Trigonal bipyramide
6	d^2sp^3	1	3	2	Octahedral

In Table 2-2 a survey of the different types of hybridization and hybrid orbitals is given. The type of hybridization depends on the number of electron groups that surround the central atom. In order to sketch the type of hybridization of a molecule you have to follow the following list:

Write down the Lewis structure (section 2.2.3 *Lewis structure*)

Count the number of electron groups that surround the central atom

The number of required hybrid orbitals equals the number of surrounding electron groups. Hybridization type is given in Table 2-2.

These three steps are followed in Example 2- M, Example 2- N and Example 2- O in this sub section. Till now we have been dealing with covalent bonds in single molecules. Now we are going to look at the bonds that exist in very large lattice structures between metal atoms. We are going into the world of metallic bonds.

2.3 Metallic bonds

In the previous sub sections we learned that the bond electrons in the covalent bonds are placed in hybrid molecular orbitals with totally specific directions. This means that the valence electrons thus are more or less “locked” in the bonds in those hybrid orbitals. Because of this “locking” of the electrons, covalent bonds generally are very poor at conducting electricity. The very low electrical conductance of covalent bonds is the exact opposite of the case with metallic bonds. Metals have very high electrical conductance in all directions which thus implies that the metallic bonds are good at conducting electricity. Therefore metallic bonds and covalent bonds must be fundamentally different. We are going to look more into that in this section. We will also see how metal atoms are arranged in different *lattice structures*.

2.3.1 Band theory

A simple model to describe metallic bonds is the so-called *electron sea model*. Metals can be considered as metal cations surrounded by valence electrons that “swim” around in all directions like in a sea. In that way, metals have high electrical and thermal conductivity in all directions since the valence electrons freely can move around. In order to describe this in more details we have to introduce the so-called *band theory*. In the band theory the molecular orbitals (that we heard about in the section 2.2.2 *Molecular orbital theory*) are again included.

We will start with the metal lithium (Li) which is the first element of the 2nd period and thus has only one valence electron (placed in the 2s-orbital). If two lithium atoms approach each other the two atomic 2s-orbitals will be transformed into two molecular orbitals; a bond orbital (σ_{2s}) and an anti-bond orbital (σ_{2s}^*) according to the theory described in section 2.2.2 *Molecular orbital theory*. If we have four lithium atom, the four atomic orbitals (2s) will be transformed into four molecular orbitals; two bond orbitals (σ_{2s}) and two anti-bond orbitals (σ_{2s}^*). From quantum mechanical considerations, the bond orbitals and anti-bond orbitals can not be degenerated. This means that they can not be equal in energy level and thus they will each have its own level of energy. If we have n lithium atoms (n is a very large number – for example $n = 6.023 \times 10^{23}$), the n atomic orbitals (2s) will be transformed into n molecular orbitals; $\frac{1}{2}n$ bond orbitals (σ_{2s}) and $\frac{1}{2}n$ anti-bond orbitals (σ_{2s}^*). Since those n molecular orbitals can not be degenerated they must all be different in energy levels. Thus those energy levels must be very close and in practice they constitute a continuous energy *band*. The described situations are show in Figure 2- 19.

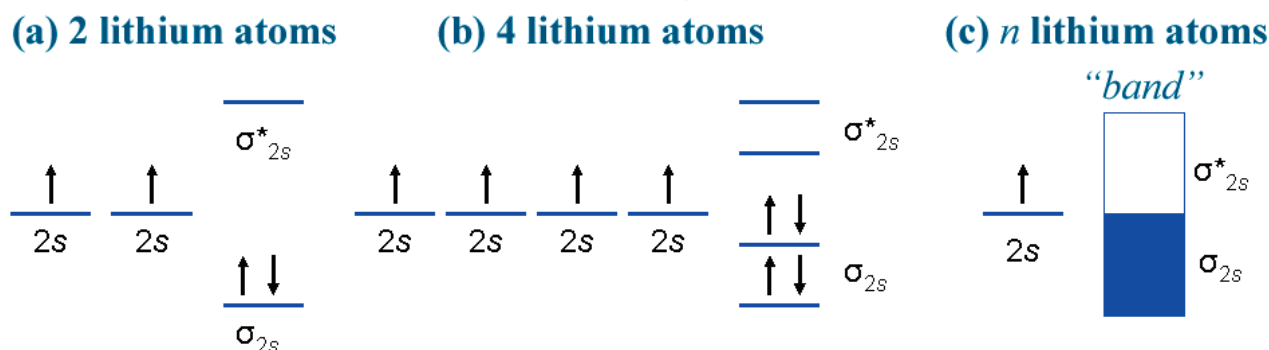

Figure 2- 19: The energy levels for the molecular orbitals for lithium metal

(a) Two lithium atoms together create two molecular orbitals. (b) Four lithium atoms together create four molecular orbitals. (c) n lithium atoms together create n molecular orbitals. When the number of atoms is large, the energy levels of the molecular orbitals created a continuous energy band.

The large amount of atomic orbitals constitutes in practice a continuous energy transition between the molecular orbitals. This is the energy *band*. The bond orbitals in lithium metal will be occupied each with one electron and the anti-bond orbitals are empty. Because the transition from bond orbital to anti-bond orbital is very small in terms of energy, the electrons can easily move from at bond orbital to anti-bond orbital. Thus is easy to get a current of electrons transported through the metallic structure because the electrons can easily move in the empty anti-bond orbitals. They can flow through the metal as an *electron sea*. This is thus an explanation of the high metallic electrical conductance in all directions from the very

simple *electron sea model* and the *band theory*. The high thermal conductivity follows in the aftermath of the high electrical conductance since the moving valence electrons transport heat as well.

2.3.2 Lattice structures

In the previous section we have seen how metal bond can be described according to the band theory. The valence electrons can freely move through the metal lattice in empty anti-bond orbitals. But how are the single atoms arranged relative to each other? We are going to look at the answer to this question in this section. Generally two types of structures in solid compounds can be distinguished:

Crystalline solid compounds

Amorphous solid compounds

In crystalline solid compounds there is a high order of systematism in the structure which is in contrast to amorphous solid compounds which are characterized by totally lack of order in the structure. Metals belong to the first category. Metal atoms are arranged in so-called *crystal lattices*. The atoms in such crystal lattices can be arranged in different manners which mans that different metals can have different types of crystal lattices. We are going to look at how these different crystal lattices are organized. Initially we assume that the metal atoms can be regarded as hard spheres that can be stacked so that they just touch each other.

Please click the advert

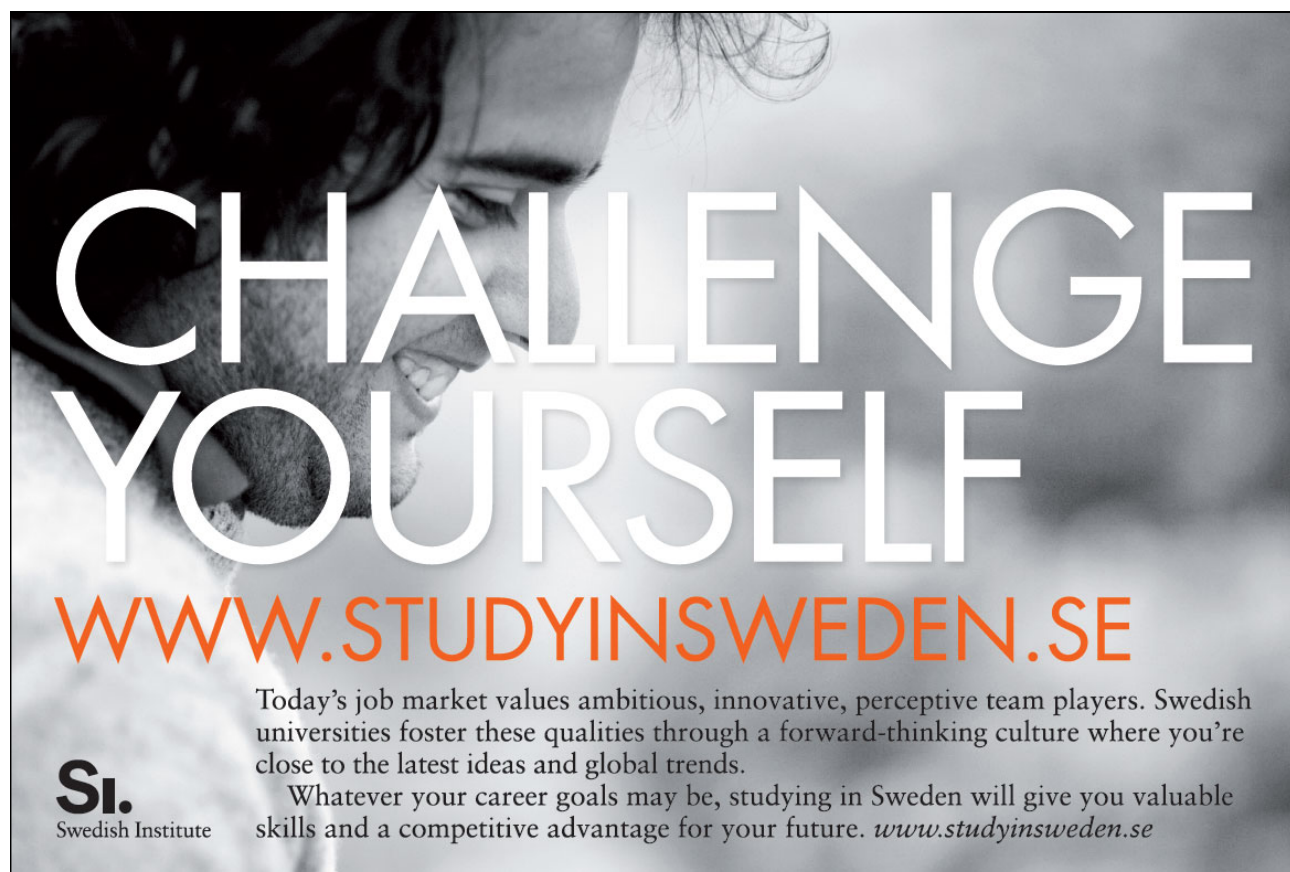

CHALLENGE YOURSELF

WWW.STUDYINSWEDEN.SE

Today's job market values ambitious, innovative, perceptive team players. Swedish universities foster these qualities through a forward-thinking culture where you're close to the latest ideas and global trends.

Whatever your career goals may be, studying in Sweden will give you valuable skills and a competitive advantage for your future. www.studyinsweden.se

Si.
Swedish Institute

Download free books at BookBooN.com

Crystal lattices are in principle build up of very small identical units. The smallest existing unit is called a *unit cell*. These small building blocks/unit cells can be compared to Lego® building blocks. They are the smallest building units and they can be built up to constitute at very large structure. We are going to see several of these unit cells in the description of the different crystal lattice structures in this section. We are mainly going to look at the four major types of structures:

Simple cubic packing (sc)

Body-centered cubic packing (bcc)

Hexagonal closest packing (hcp)

Face-centered cubic packing (fcc)

The simplest lattice structure is the so-called *simple cubic packing* (sc). This structure consists of identical layers of atoms placed exactly above and below each other. The structure is sketched in Figure 2- 20.

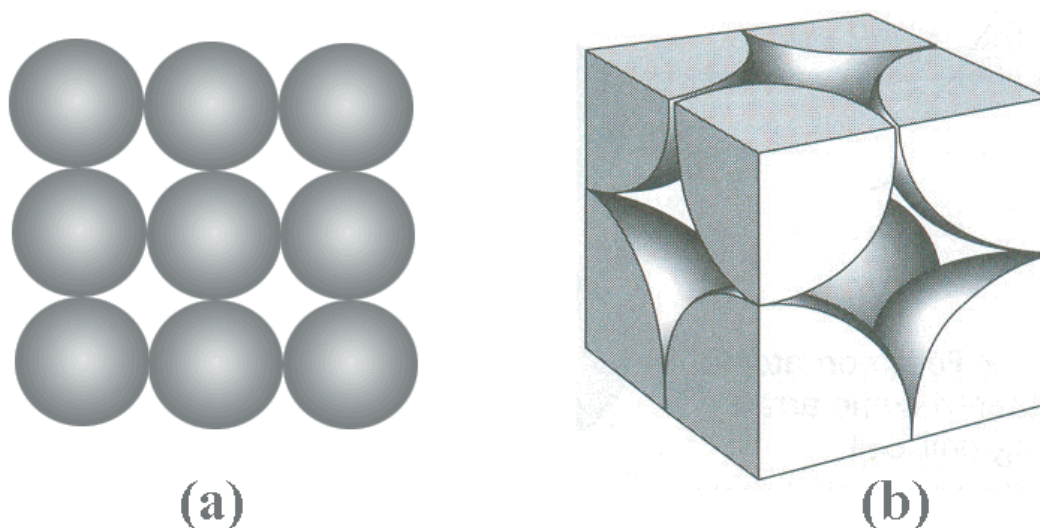

Figure 2- 20: Simple cubic packing (sc)

(a) One layer of the structure. (b) Unit cell. In the simple cubic packing every layer is placed exactly above and below each other. Thereby every atom touches six other atoms (four in the same layer, one above and one below). Thus the coordination number is 6.

Only the metal polonium (Po) has its atoms arranged in a simple cubic packing structure. In Figure 2- 20b it is seen that the unit cell in the sc-structure consists of 1 atom in total ($8 \times 1/8$ part of an atom). From the unit cell it is further seen that the atoms touche along the edges of the unit cell. Thus the lengths of the edges of the unit cell equals 2 times the atomic radius ($b = 2 \times r$). The length of the edges of the unit cell is denoted b and the atomic radius is denoted r . Each atom in the sc-structure thus touches 6 other atoms and therefore the so-called *coordination number* is 6.

The atoms in a metal can also be packed according the so-called *body-centered cubic* packing structure (bcc). In this structure identical layers of atoms are placed above and below each other so that every second layer is

exactly above and below each other. The atoms in one layer is placed above the holes in the below and above lying layer. This is sketched in Figure 2- 21a.

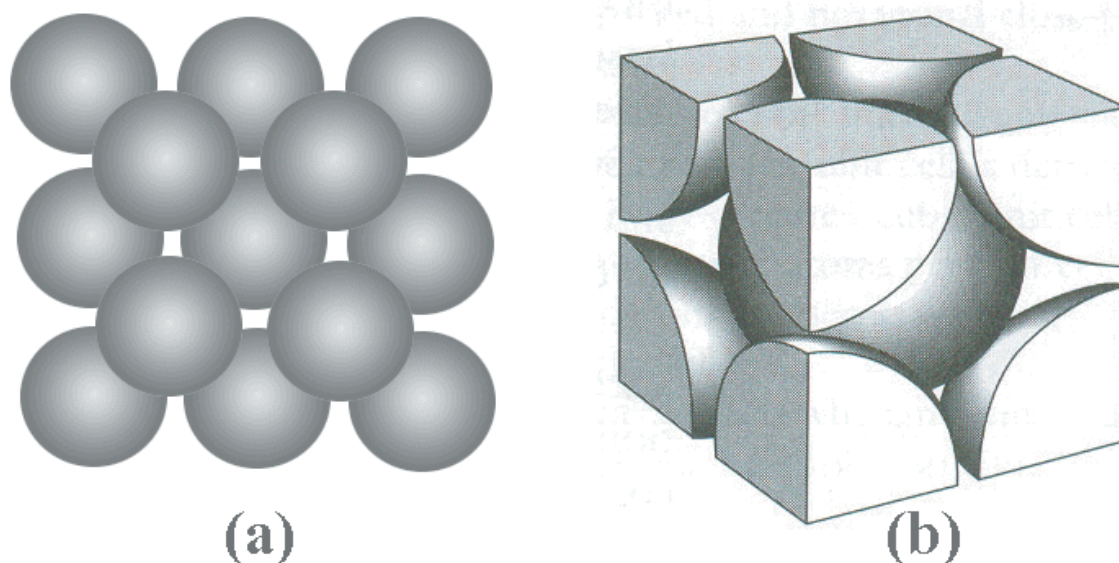

Figure 2- 21: Body-centered cubic packing (bcc)

(a) Two layers of the structure. (b) Unit cell. Every second layer is placed exactly above and below each other. Every atom touches eight other atoms (four in the layer below and four in the layer above). Thus the coordination number is 8.

In Figure 2- 21 it is seen that the atoms do not touch each other in the respective layers but they rather touch the atoms in the layer below and above. From the sketch of the unit cell it is seen that the atoms touch along the diagonal through the unit cell which gives rise to the name *body-centered* structure. Thus the length of the body-diagonal of the unit cell equals 4 times the atomic radius. By using the theorem of Pythagoras the length of the edge of the unit cell b is thus equal to: $b = (4/3^{1/2}) \times r$. The unit cell contains 1 whole atom plus 8 times $1/8$ parts of atoms which correspond to 2 atoms in total in the unit cell. Each atom touches eight other atoms which give rise to a coordination number of 8 for this structure.

In stead of a square based arrangement of the atoms in each layer (as in the *sc* and *bcc* structures), the atoms can be arranged in a hexagonal manner. This means that each atom does not have four neighbours but rather six neighbours in a layer. That way the holes between the atoms in the layer will by far be smaller compared to the *sc* and *bcc* structures and overall the atoms will packed closer together. There are two different types of hexagonal structures. The first is the *hexagonal closest packed* structure (*hcp*) and the second is the *face-centred cubic* structure (*fcc*). The hexagonal closest packed structure (*hcp*) is sketched in Figure 2- 22. In this structure every second layer is placed exactly above and below each other.

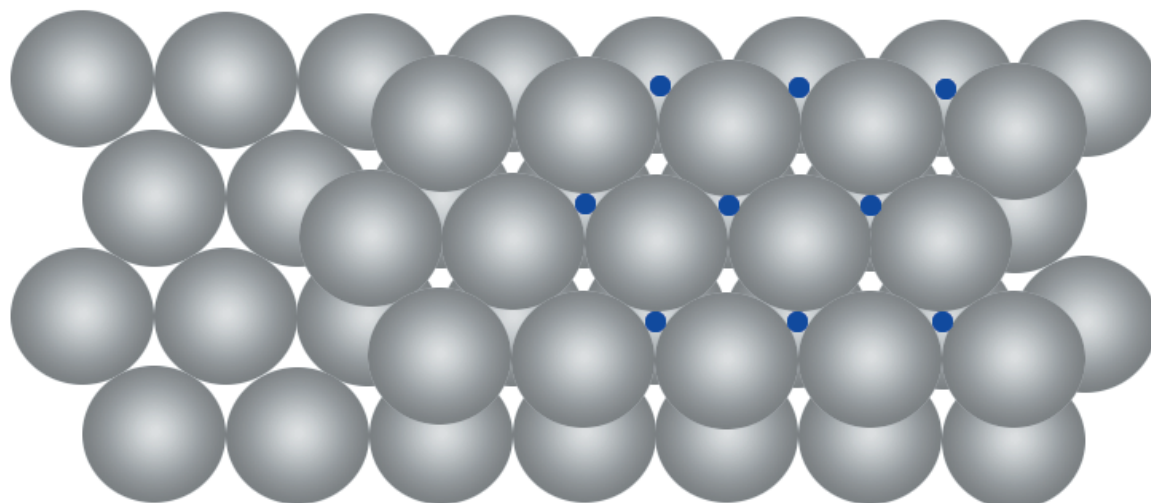

Figure 2- 22: Hexagonal closest packing (hcp)

Every second layer is placed exactly above and below each other. The centres of the atoms in the third layer are sketched with small blue dots. The third layer is placed exactly above the first layer. Every atom touches twelve other atoms (six in the same layer, three in the layer below and three in the layer above). Thus the coordination number is 12.

Please click the advert



oxygen.ie

Download 3rd level revision guides for free
– brought to you by oxygen.ie

Download free books at BookBooN.com

Since each atom in the hcp-structure touches twelve other atoms (six in the same layer, three in the layer below and three in the layer above) the coordination number is 12. A unit cell for this structure can not be drawn as easily as for the other structures and thus only the layered structure is shown in Figure 2- 22. It is seen that it is only half of the “holes” in the layers that are covered by atoms in the layer above/below.

The other hexagonal packed structure is the so-called *face-centred cubic* structure (*fcc*). Here every third layer is placed above the holes in the first layer which means that every fourth layer is placed exactly above each other. The layered structure and the unit cell for the *fcc*-structure are sketched in Figure 2- 23.

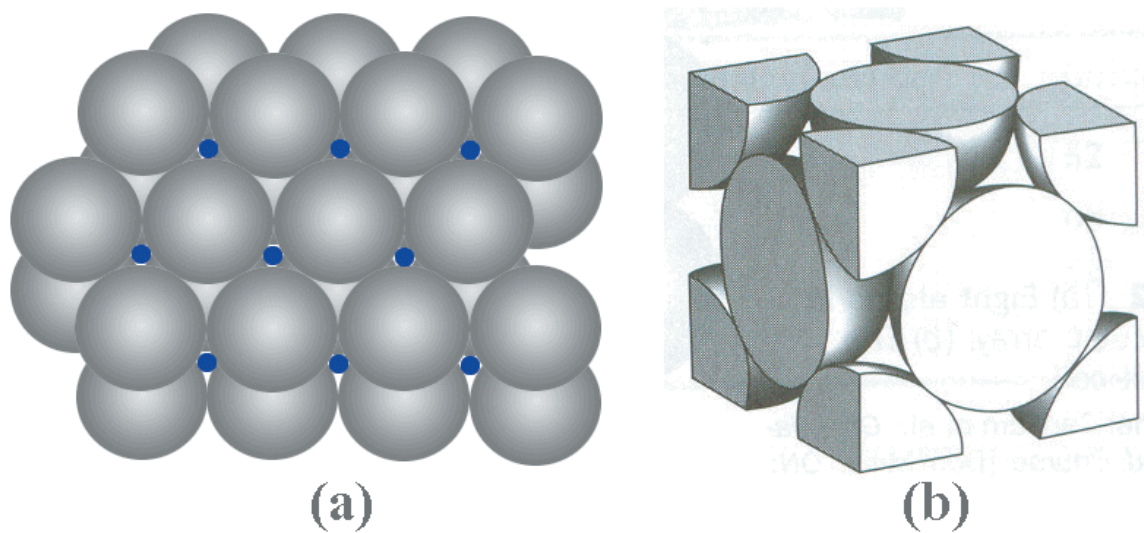

Figure 2- 23: Face-centered cubic packing (fcc)



(a) The centre of the atoms in the third layer is placed above the holes in the first layer and the centres of the atoms in the third layer are sketched with small blue dots. (b) Unit cell. Every atom touches twelve other atoms (six in the same layer, three in the layer above and three in the layer below). Thus the coordination number is 12.

By comparing Figure 2- 22 and Figure 2- 23a it is seen that the difference between the *hcp*-structure and the *fcc*-structure lies in the placement of the third layer. As for the *hcp*-structure each atom in the *fcc*-structure touches twelve other atoms (six in the same layer, three in the layer below and three in the layer above). Thus the coordination number is 12. From the unit cell it is seen that the atoms touch each other along the diagonal of the “faces” of the unit cell. Thus the name of this structure is *face-centred* cubic structure, and the face-diagonal equals four times the atomic radius. By using the theorem of Pythagoras the length of the unit cell b can be calculated according to: $b = (8^{1/2}) \times r$. The unit cell contains six half atoms plus eight 1/8 parts of atoms which gives a total of 4 atoms pr. unit cell.

A survey of the four different structures is given in Table 2- 3.

Table 2- 3: Crystal lattice structures

The side length in the unit cell is denoted b and the radius of the atoms is denoted r . SC: simple cubic packing, BCC: Body-centered cubic packing, FCC: Face-centered cubic packing, HCP: Hexagonal closest packing.

Structure	Sketch	$b = f(r)$	Number of atoms in unit cell	Example
sc		$b = 2 \times r$	1	Polonium
bcc		$b = (4/3^{1/2}) \times r$	2	Niobium
fcc		$b = (8^{1/2}) \times r$	4	Osmium
hcp	*	-	-	Palladium

*The unit cell for the hcp-structure is not given since it can not be sketched with the same methodology as for the other structures.

We are now able to determine the side length of a unit cell for different well known lattice structures from the atomic radius according to Table 2- 3. We also know the number of atoms in each unit cell and thus we can calculate the density of a metal from the way the atoms in the metal is packed and the atomic radius of the metal atoms. We are going to try this in the following example.

Example 2- P:*Density of tungsten (W)*

The transition metal tungsten (W) assumes *bcc*-structure. The atomic radius of tungsten atoms is 1.37 Å ($r = 1.37 \times 10^{-8} \text{ cm}$) and the molar mass of tungsten is $M_w = 183.84 \text{ g/mole}$. What is the density of tungsten metal?

We know that when we are dealing with *bcc*-structures each unit cell contains 2 atoms (see Table 2- 3 on page 84). The density of tungsten metal can thus be determined as follows:

$$\text{Density of tungsten} = \frac{\text{Mass of 2 W - atoms}}{\text{Volume of unit cell}}$$

The mass of 2 tungsten atoms can be calculated from the molar mass and Avogadro's number.

$$\text{Mass of 2 W - atom} = \frac{M_w}{N_A} \cdot 2 = \frac{183.84 \frac{\text{g}}{\text{mole}}}{6.022 \cdot 10^{23} \text{ mole}^{-1}} \cdot 2 = \underline{6.106 \cdot 10^{-22} \text{ g}}$$

The volume of the unit cell is determined from the atomic radius since we know the connection between the side length of the unit cell b and the atomic radius r according to Table 2- 3 on page 84.

$$\text{Volume of unit cell} = b^3 = \left[\left(\frac{4}{3^{1/2}} \right) \cdot r \right]^3 = \left[\left(\frac{4}{3^{1/2}} \right) \cdot 1.37 \cdot 10^{-8} \text{ cm} \right]^3 = \underline{3.167 \cdot 10^{-23} \text{ cm}^3}$$

The density of tungsten metal can now be calculated.

$$\text{Density of tungsten} = \frac{6.106 \cdot 10^{-22} \text{ g}}{3.167 \cdot 10^{-23} \text{ cm}^3} = \underline{\underline{19.28 \text{ g/cm}^3}}$$

The calculations can also go the other way. If the density of a metal and packing structure is known, the atomic radius can be calculated. We are going to try this in the following example.

Example 2- Q:*Atomic radius for ruthenium (Ru)*

The transition metal ruthenium (Ru) has *fcc*-structure. The density of ruthenium metal is 12.34 g/cm^3 and the molar mass is $M_{\text{Ru}} = 101.07 \text{ g/mole}$. What is the atomic radius of ruthenium atoms?

We know that when we are dealing with *fcc*-structure each unit cell contains 4 atoms according to Table 2-3 on page 84. The volume of the unit cell can thus be determined as follows:

$$\text{Volume of unit cell} = \frac{\text{Mass of 4 Ru - atoms}}{\text{Density of Ruthenium}}$$

The mass of 4 ruthenium atoms is calculated from the molar mass and the Avogadro's number.

$$\text{Mass of 4 Ru - atoms} = \frac{M_{\text{Ru}}}{N_A} \cdot 4 = \frac{101.07 \frac{\text{g}}{\text{mole}}}{6.022 \cdot 10^{23} \text{ mole}^{-1}} \cdot 4 = \underline{6.713 \cdot 10^{-22} \text{ g}}$$

The volume of the unit cell is calculated.

$$\text{Volume of unit cell} = \frac{6.713 \cdot 10^{-22} \text{ g}}{12.37 \text{ g/cm}^3} = \underline{5.427 \cdot 10^{-23} \text{ cm}^3}$$

The volume of the unit cell equals the side length of unit cell raised to the power of three (Volume = b^3). Since we know the association between the side length b of the unit cell and the atomic radius r according to Table 2-3 on page 84, the atomic radius of ruthenium can now be calculated.

$$\begin{aligned} \text{Volume of unit cell} = b^3 &= \left[\left(8^{1/2} \right) \cdot r \right]^3 \Leftrightarrow \\ r &= \frac{(\text{Volume of unit cell})^{1/3}}{8^{1/2}} = \frac{(5.427 \cdot 10^{-23} \text{ cm}^3)^{1/3}}{8^{1/2}} = 1.34 \cdot 10^{-8} \text{ cm} = \underline{1.34 \text{ \AA}} \end{aligned}$$

Now we have been looking at metallic bonds and how metal atoms arrange in crystal lattice structures. In the following section we are going to look at the ionic bonds and compounds.

2.4 Ionic bonds

The transition from pure covalent bonds over polar covalent bonds to ionic bonds is fluent as described in the section 2.1.1 *Bond types*. In this section we are going to look at bonds with ionic character. We are also

going to look at how ionic compounds often are arranged in crystal lattices similar to the metallic structures described in the section 2.3.2 *Lattice structures*.

2.4.1 Ionic character

When the electronegativity between two atoms is zero (two identical atoms) you have a pure covalent bond while the bond is polar covalent if there is a difference in electronegativity between the atoms. When this difference in electronegativity reaches a certain level, at which the bond electrons in practice are totally placed around the most electronegative atom, the bond is categorized as ionic since we no longer have a bond electron pair but rather some electrostatic interactions between a cation and an anion. For chemical bonds you can talk about how much ionic character the bond exhibits. The ionic character can be calculated based on electron charge and bond distance which we will not go further into in this book. A relative connection between the degree of ionic character and difference in electronegativity between the atoms is sketched in Figure 2- 24.

Please click the advert



DIVERSE - INNOVATIVE - INTERNATIONAL

Are you considering a European business degree?

Copenhagen Business School is one of the largest business schools in Northern Europe with more than 15,000 students from Europe, North America, Australia and Asia.

Are you curious to know how a modern European business school competes with a diverse, innovative and international study environment?

Please visit Copenhagen Business School at www.cbs.dk

 **Copenhagen Business School**
HANDELSHØJSKOLEN

Diversity creating knowledge

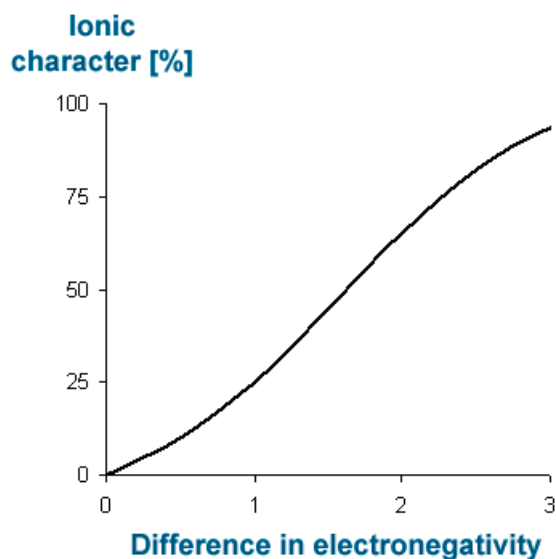

Figure 2- 24: Ionic character

Connection between the ionic character of a bond and the difference in electronegativity between the two atoms in a bond.

A pure covalent bond (an H-H bond for example) exhibits 0 % ionic character while a polar covalent bond like hydrogen fluoride (H-F) exhibits 42 % ionic character. Bonds in sodium chloride (NaCl) are normally considered as ionic. These sodium chloride bonds exhibit 72 % ionic character. This emphasizes that the transition between covalent bonds over polar covalent bonds to ionic bonds is very fluent. No bonds actually exhibit 100 % ionic character since the bond electrons always will be located around the less electronegative atom at least for just a very little percentage of the time.

The strength of an ionic bond depends on the size of the ions. The smaller an ion is, the smaller is the surface area. This means that the charge of the ion only has to be distributed throughout a smaller area and the *charge density* thus increases when the ionic radius decreases. When the charge density is larger, the ionic bonds increase in strength. Therefore a LiF bond is stronger than a LiI bond since the radius of fluoride is smaller than the radius of iodide and thus the charge density of fluoride is larger than for iodide. This means that fluoride will be stronger bonded to the lithium ion than iodide.

2.4.2 Lattice structures for ionic compounds

We saw in the section 2.3.2 *Lattice structures* that metal atoms are arranged in different crystal lattice structures. The same is the case for many solid ionic compounds. The anions are often much larger than the cations so these anions often constitute the lattice structure and the cations are then located in the “holes” in the lattice structure. As for the metal atoms we assume that the ions are hard spheres that can be packed together so that they just touch each other. The ratio between the radius of the cations and the anion determines which lattice structure the ionic compound adopts. This ratio is called the r_+/r_- ratio. In Table 2- 4 you can see which structure the ionic compounds adopt at the different r_+/r_- ratios. Of course there are some

exceptions which you can find information about in more detailed educational textbooks. The coordination number tells how many anions each cation touches in the lattice structure.

Table 2- 4: Structures for ionic compounds

The structure of an ionic compound depends on the r_+/r_- ratio. The coordination number tells how many anions each cation touches.

r_+ / r_- ratio	Coordination number	Name of structure	Example
0.732 – 0.999	8	Cubic	CsCl
0.414 – 0.732	6	Octahedral	NaCl
0.225 – 0.414	4	Tetrahedral	ZnS

When the r_+/r_- ratio is between 0.732 and 0.999 the structure is cubic. In this case the cations and anions are not that different in size and the structure corresponds to the simple cubic structure (sc) that we heard about for metals (section 2.3.2 *Lattice structures*). Anions and cations will be placed in a simple cubic structure so that each cation will be surrounded by eight anions and vice versa. A unit cell for such a structure is shown in Figure 2- 25.

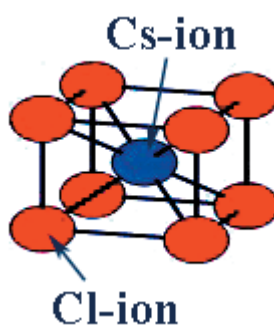

Figure 2- 25: Cubic structure for an ionic compound

Unit cell for a cubic structure for an ionic compound with a r_+/r_- ratio in the interval 0.732 – 0.999. Each cation touches eight anions and each anion touches eight cations. Cesium chloride (CsCl) is an example of an ionic compound with cubic structure.

In Figure 2- 25 it is sketched that in the unit cell the ions touch along the diagonal through the unit cell. This means that the diagonal has a length that corresponds to $2 \times \text{radius of anion} + 2 \times \text{radius of cation}$. Such a structure is seen for cesium chloride.

When the r_+/r_- ratio is between 0.414 and 0.732 the structure is octahedral. This means that the cations are placed in the octahedral holes in the anionic lattice. This structure is called *sodium chloride structure* because the very well known common salt has this structure. The sodium chloride structure for a unit cell is sketched in Figure 2- 26.

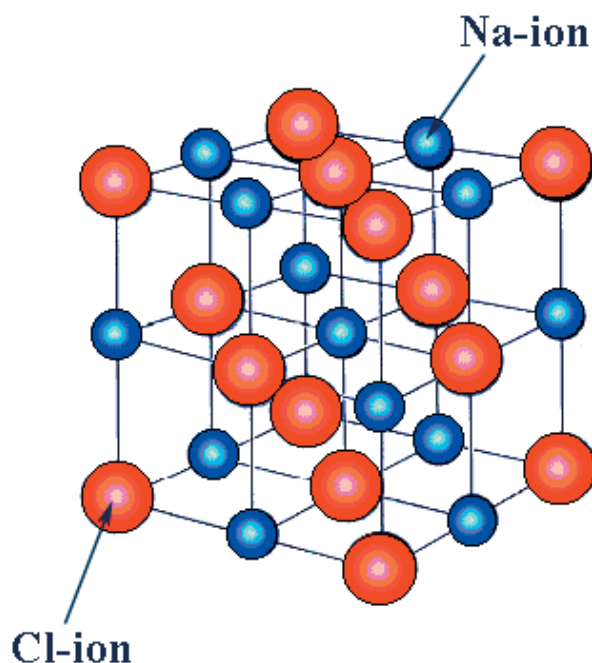

Figure 2- 26: Octahedral structure for an ionic compound

Octahedral structure for an ionic compound with a r_+/r_- ration in the interval 0.414 – 0.732. The cations are placed in the octahedral holes in the anion lattice. Thus each cation touches six anions. This structure is often called sodium chloride structure since the very well known "common salt" has this structure.

Please click the advert



Sharp Minds - Bright Ideas!

Employees at FOSS Analytical A/S are living proof of the company value - First - using new inventions to make dedicated solutions for our customers. With sharp minds and cross functional teamwork, we constantly strive to develop new unique products - Would you like to join our team?

FOSS works diligently with innovation and development as basis for its growth. It is reflected in the fact that more than 200 of the 1200 employees in FOSS work with Research & Development in Scandinavia and USA. Engineers at FOSS work in production, development and marketing, within a wide range of different fields, i.e. Chemistry, Electronics, Mechanics, Software, Optics, Microbiology, Chemometrics.

We offer
A challenging job in an international and innovative company that is leading in its field. You will get the opportunity to work with the most advanced technology together with highly skilled colleagues.

Read more about FOSS at www.foss.dk - or go directly to our student site www.foss.dk/sharpminds where you can learn more about your possibilities of working together with us on projects, your thesis etc.

The Family owned FOSS group is the world leader as supplier of dedicated, high-tech analytical solutions which measure and control the quality and production of agricultural, food, pharmaceutical and chemical products. Main activities are initiated from Denmark, Sweden and USA with headquarters domiciled in Hillerød, DK. The products are marketed globally by 23 sales companies and an extensive net of distributors. In line with the corevalue to be 'First', the company intends to expand its market position.



Dedicated Analytical Solutions

FOSS
 Slangerupgade 69
 3400 Hillerød
 Tel. +45 70103370
www.foss.dk

In Figure 2- 26 it is seen that the cations are placed in the octahedral holes in the anionic lattice. Thus the cations each have six anion neighbours. From geometrical considerations the radius of the octahedral holes be calculated from the radius of the anions according to equation (2- 4).

$$r_{\text{octahedral holes}} = 0.414 \cdot r_{\text{anion}} \quad (2- 4)$$

When the r_+/r_- ratio is between 0.225 and 0.414 the structure is tetrahedral. In this case the cations are relatively small compared to the anions. Thus they fit into the tetrahedral holes of the anion structure. This is sketched for a zinc sulphide lattice in Figure 2- 27.

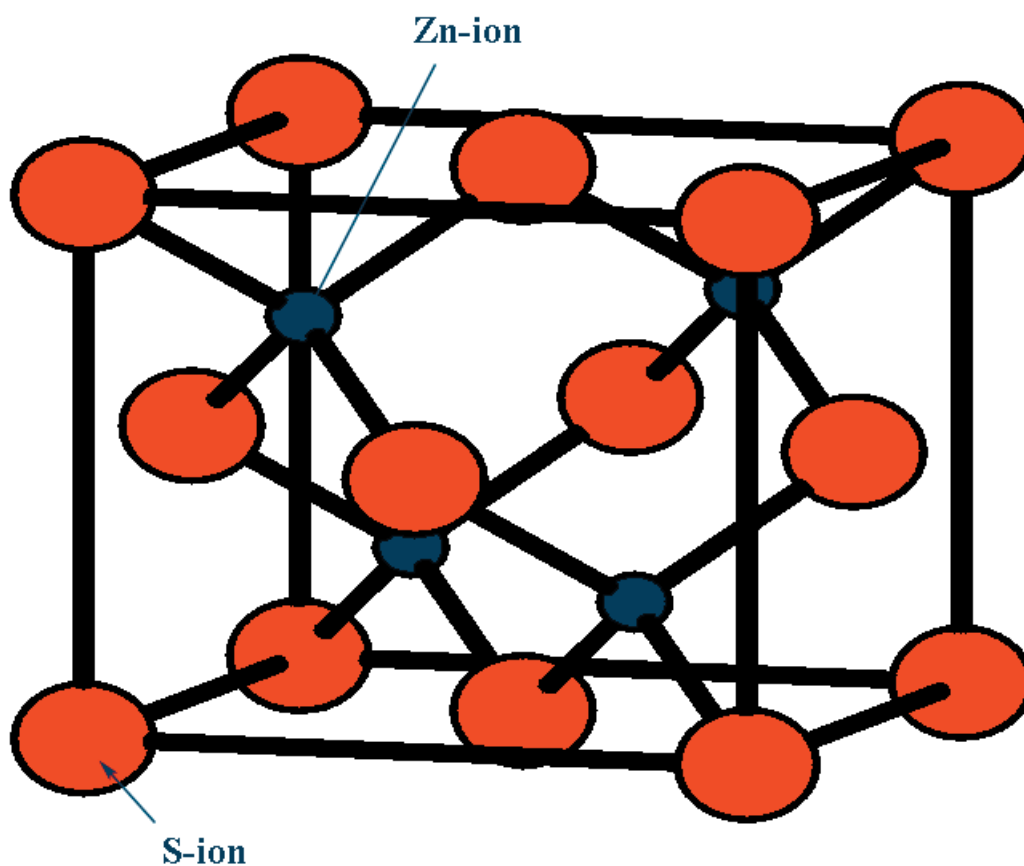

Figure 2- 27: Tetrahedral structure for an ionic compound

Ionic compound with a r_+/r_- ratio in the interval 0.225 – 0.414. The cations are placed in the tetrahedral holes of the anion structure. Thus each cation touches four anions. Zinc sulphide (ZnS) is an example of an ionic compound with tetrahedral structure.

The anions are arranged in a cubic close packed system and the cations are located in the tetrahedral holes of this structure. Thus each cation has four anion neighbours. From geometrical considerations the radius of the tetrahedral holes can be calculated from the radius of the anions according to equation (2- 5).

$$r_{\text{tetrahedral holes}} = 0.225 \cdot r_{\text{anion}} \quad (2- 5)$$

By looking at the equations (2- 4) and (2- 5) you can see why it is at the r_+/r_- ratios of 0.225 and 0.414 (according to Table 2- 4 on page 89) that we have the lower limits for the tetrahedral and octahedral structures respectively.

2.4.3 Energy calculations in ionic compounds

In the previous section we saw how ionic compounds are often arranged in different lattice structures depending on the ratio between the cation radius and the anion radius. In this section we are going to look at the *lattice energy* in an ionic compound and how you can calculate the total change in energy when for example lithium metal and fluorine gas reacts into solid lithium fluoride. Based on this specific compound we will see how a combination of different terms such as the lattice energy, ionization energy and sublimation energy can lead us to calculate a specific energy term.

Please click the advert

**Design your
own future at
MAN Diesel**

www.mandiesel.com

MAN Diesel – Powering the World



Download free books at BookBooN.com

Example 2- R:

Energy calculations for lithium fluoride (LiF)

What is the total change in energy when lithium metal reacts with fluor gas and forms solid lithium fluoride?

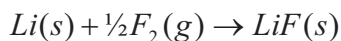

The energy changes are sketched in Figure 2- 28. We are looking at the case where 1 mole of lithium atoms reacts with a $\frac{1}{2}$ mole of fluor gas molecules and 1 mole of solid lithium fluoride is formed.

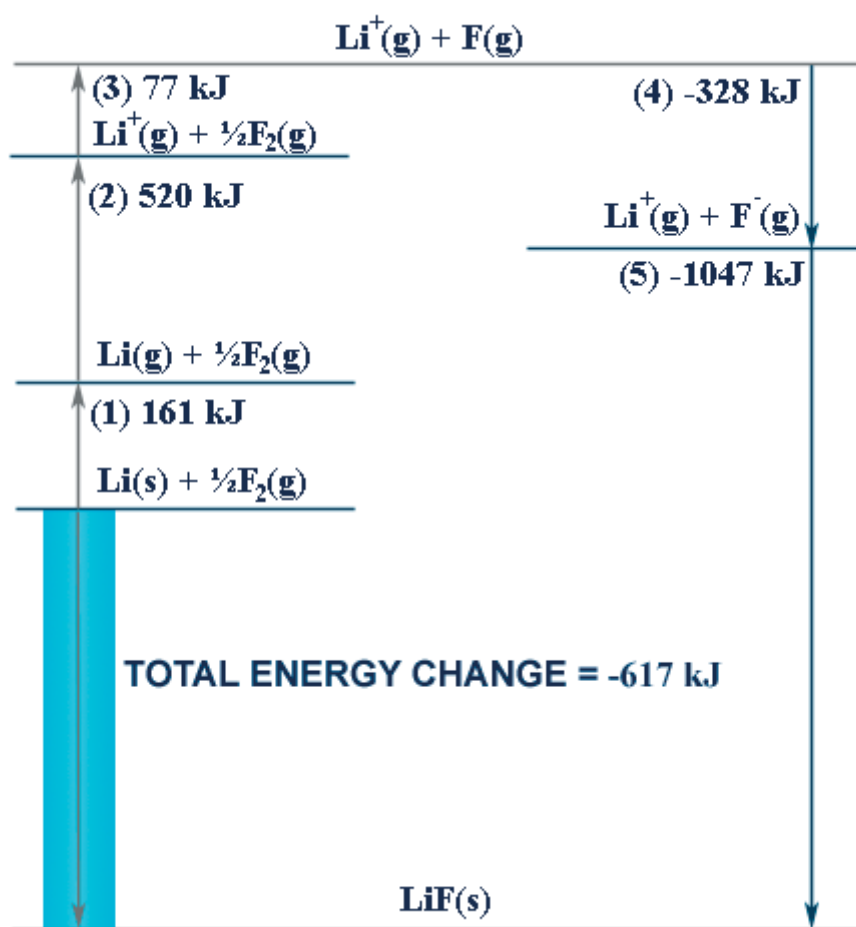

Figure 2- 28: Energy diagram for the formation of lithium fluoride

The arrows pointing upwards indicate that energy has to be supplied in order to make the reaction occur. The arrows pointing downwards indicate that energy is released when the reaction occurs. 1 mole of solid lithium fluoride is formed.

The single steps are explained below:

The first step is to sublime the lithium metal into lithium gas. The sublimation enthalpy is 161 kJ/mole. Thus 161 kJ are required.

The second step is to get the lithium gas atom ionized. The ionization energy for lithium is 520 kJ/mole. Thus 520 kJ are required.

The third step is to break the covalent F-F bonds in order to get single fluor atoms. It requires 154 kJ/mole to break the bonds and since a half mole of bonds are to be broken, 77 kJ are required.

The fourth step is to let the fluor atom each adopt an electron. The energy change here is thus the electron affinity for fluor which is -328 kJ/mole. Thus 328 kJ are released.

The fifth step is to let the lithium ions and the fluoride react and form solid lithium fluoride. The energy change here corresponds to the lattice energy for LiF which is 1047 kJ/mole. Thus when 1 mole of LiF is formed from the gaseous ions, 1047 kJ will be released.

The total change in energy can thus be determined by summing up the energies in the five steps.

$$\text{Total energy change} = (161 + 520 + 77 + (-328) + (-1047))\text{kJ} = \underline{\underline{-617\text{kJ}}}$$

Thus 617 kJ are released when 1 mole of LiF(s) is formed from 1 mole of Li(s) and $\frac{1}{2}$ mole of F₂(g)

By setting up an energy diagram as in Figure 2- 28 you are able to calculate different energy terms when the other terms are known. Many of the terms can be looked up in tables in the literature and educational textbooks.

2.5 Summing up on chapter 2

In this chapter we have been looking at three types of chemical bonds; covalent bond, ionic bonds and metallic bonds. The bonds are described by using different models and theory which introduce the molecular orbitals. These molecular orbitals are formed from atomic orbitals which we heard about in chapter 1.

In the section 2.2 *Covalent bonds* we first introduced some considerations about energy changes associated with formation of chemical bonds. We concluded that in order for a chemical bond to be formed the total energy between the two atoms must have a minimum at a certain distance between the atoms. This distance is thus the length of the covalent bond. Molecular orbital theory could be used in the explanation of why some atoms join and form molecules while others do not. Here we introduced the bond orbitals and the anti-bond orbitals. By use of the molecular orbital theory we were able to predict bond orders. Thus we can predict whether a bond is a single, double or triple bond. In order to talk about the arrangement of the different atoms inside a molecule or composite ion we learned to write down the Lewis structure. This Lewis structure could also tell about the bond order and the placement of the electrons groups (lone pairs bond electron pairs) around the central atom in a molecule or composite ion. Such information is useful when the VSEPR theory is to be applied. The VSEPR theory tells us that the electron groups around an atom will be placed as far apart as possible. Thus the VSEPR theory is a tool that helps us to predict the actual geometry of a molecule or composite ion. However the VSEPR theory tells nothing about where the different electron groups precisely are located or to put it another way; in which orbitals are the electron groups hosted? In

order to answer this question we have to use the orbital hybridization theory. From this theory we know that atomic orbitals transform or “melt” into molecular hybrid orbitals with the “right” orientation in space according to the VSEPR theory. The type of hybridization depends on how many electron groups that surround the central atom.

The bond electrons in covalent bond are very “locked” in the hybrid orbitals which gives very poor electrical conductance. This is in contrast to the bonds in metals. These bonds can be described by an *electron sea model* that tells us that the valence electrons freely can move around in the metal structure. The band theory tells us that the valence electrons move around in empty anti-bond orbitals that all lie very close in energy to the bond orbitals. The free movement of electrons in metals explain the very high electrical and thermal conductivity of metals. Metal atoms are arranged in different lattice structures. We saw how knowledge about the lattice structure and atomic radius can lead to calculation of the density of a metal.

Ionic bonds are described as well. The transition from covalent over polar covalent to ionic bonds is very fluent and depends on the difference in electronegativity between the atoms. The covalent bonds consist of sharing an electron pair and ionic bonds are electrostatic interactions between a cation and an anion. Solid ionic compounds are often arranged in lattice structures with many similarities with the lattice structures that we saw for the metallic compounds. The type of lattice structure for solid ionic compound depends on the ration between the radius of the cation and anion.

Please click the advert

The advertisement features a light blue background with a central graphic. The graphic consists of four square icons arranged horizontally, separated by plus signs and an equals sign. From left to right: a black square with a white shopping cart icon labeled 'Student Discounts'; a blue square with a white calendar icon showing '2009' labeled 'Student Events'; a grey square with a white pound sterling symbol (£) labeled 'Money Saving Advice'; and a yellow square with a white star icon labeled 'Happy Days!'. Below the graphic, the text 'wealthystudent.co.uk' is displayed in a dark grey font, with 'wealthy' in a larger, bold font and 'student.co.uk' in a smaller font.

Download free books at BookBooN.com

3. Reactions kinetics

Central for the applications of chemistry in practise is the understanding of chemical reaction kinetics. We will in this chapter begin with the fundamental understanding of the chemical reaction and how to write the chemical stoichiometric equation followed by a deeper presentation of the chemical reaction kinetics.

3.1 The chemical reaction

A chemical reaction is defined by the products and reactants taking part of the reaction. First when all products and reactants are known from e.g. experiments it becomes possible to set up the chemical stoichiometric equation in order to make sure that there are an equal number of atoms on each side of the reaction arrow. Thus, the stoichiometry must be fulfilled.

There are certain principles when a stoichiometric equation is to be set up. A reaction scheme is a symbolic way to represent a chemical reaction. A reaction scheme must express as much right information as possible. It is often advantageous to write a reaction scheme by the following bullets:

- Reactants are written on the left side and products on the right side.
- The species are written on the form that they are in before and after the chemical reaction.
- Only species that participate in the reaction are included.
- As term for the reaction a double arrow \leftrightarrow is used as there is in principle and equilibrium. Is this equilibrium displaced to the right a single arrow may be used \rightarrow and similarly \leftarrow may be used if the reaction is displaced to the left. In the last case no reaction exists.

Example 3- A:

Reaction equation for precipitation of $BaSO_4$

Write the reaction scheme for precipitation of barium sulphate ($BaSO_4$) by addition of barium chloride ($BaCl_2$) to a aqueous solution of sodium sulphate (Na_2SO_4):

Following the general rules one achieves:

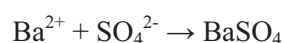
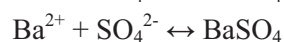
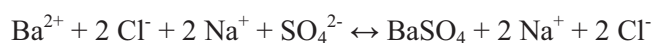
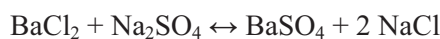

In which the last two lines is the correct way of writing as they fulfil all the above mentioned rules.

In all chemical reactions it is necessary to know the spontaneity of the reaction thereby indicating the willingness of the reaction to proceed all by itself. That a reaction is spontaneous does not necessarily mean that the reaction also is fast. This means that even if a reaction is spontaneous it may e.g. take many years before the amount of product is sufficient. Hence, it is essential to know something about the rate of reaction. The part of the chemistry is known as *chemical reaction kinetics* and this is the subject for the following chapter.

Example 3- B:*Production of ammonia*

The production of ammonia NH_3 is one of the most important chemical reactions and is used as e.g. fertiliser. Roughly 20 millions tonnes of ammonia is produced each year. The formation of ammonia may from a thermodynamically viewpoint be expressed as:

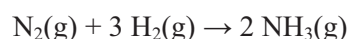

Does one however have N_2 and H_2 on gas form side by side at 25 °C, no reaction will take place. This is caused by the fact that the rate of reaction is extremely slow at 25 °C. One has to find other methods for producing NH_3 in practise. This illustrates that even if the reaction actually may proceed from a thermodynamic point of view and even if the stoichiometry fits it is not certain that the reaction actually will take place fast enough to exploit the reaction in practise. It is necessary in addition to know something about the rate of reaction.

3.2 Rate of reaction

We will introduce the term reaction velocity in this chapter. For a chemical reaction it is the concentration of reactants or products changing with time. For an arbitrary specie A with the concentration in moles/litres the rate of reaction may be expressed as:

$$\text{Rate of reaction} = \frac{\Delta[A]}{\Delta[t]} \rightarrow \frac{d[A]}{dt} \quad (3- 1)$$

Example 3- C:*Decomposition of nitrogen dioxide*

In an experiment we begin by having a flask of gas filled with NO₂ at room temperature (25 °C). At this temperature NO₂ is stable, but if the gas is heated up to 300 °C, it decompose to NO and O₂ following the following reaction scheme:



By measurement of the concentration of the three gases as function of time, the following data is obtained:

Time in seconds	Concentration of NO ₂	Concentration of NO	Concentration of O ₂
0	0,01	0	0
50	0,0079	0,0021	0,0011
100	0,0065	0,0035	0,0018
150	0,0055	0,0045	0,0023
200	0,0048	0,0052	0,0026
250	0,0043	0,0057	0,0029
300	0,0038	0,0062	0,0031
350	0,0034	0,0066	0,0033
400	0,0031	0,0069	0,0035

By applying equation (3-1) it becomes possible to determine the velocity, by which O₂ is formed. For instance is O₂ formed in the time interval 150 s → 200 s with the velocity:

$$\text{Rate of reaction (formation of O}_2) = \frac{\Delta[A]}{\Delta[t]} = \frac{(0,0029 \text{ mol/L} - 0,0026 \text{ mol/L})}{(200 \text{ s} - 150 \text{ s})} = 6,0 \cdot 10^{-6} \frac{\text{mol}}{\text{L} \cdot \text{s}}$$

while the velocity in the interval 350 s → 400 s is:

$$\text{Rate of reaction (formation of O}_2) = \frac{\Delta[A]}{\Delta[t]} = \frac{(0,0035 \text{ mol/L} - 0,0033 \text{ mol/L})}{(400 \text{ s} - 350 \text{ s})} = 4,0 \cdot 10^{-6} \frac{\text{mol}}{\text{L} \cdot \text{s}}$$

It is thereby worth noting that the rate of reaction is not a constant factor but actually decreases with time in this case.

Following the stoichiometric scheme for the conversion of NO_2 two molecules of NO_2 is converted each time one molecule of O_2 is formed. It is thereby easy to understand that the rate of reaction for the conversion of NO_2 must be given by the double of the velocity for the formation of O_2 . hence, we may summarise the rate of reaction as follows:

$$\text{Velocity for the use of } \text{NO}_2 = \text{Velocity for the formation of } \text{NO} = 2 \cdot \text{Velocity for the formation of } \text{O}_2$$

3.3 Rate expressions

So far we have only looked at irreversible reactions but as mentioned earlier all reactions are in principle reversible meaning that the reactions run in both directions. In the prior example with the decomposition of nitrogen dioxide the following reaction may also take place if there is excess O_2 available:



Such contra dictionary reactions have naturally importance regarding the writing of the rate expressions. Typically, complications are avoided but neglecting the reversible reaction and thereby assume that the rate of reaction only depends on the concentration of the reactants. For the decomposition of nitrogen dioxide the rate expressions is written as:

$$\text{Rate of reaction} = k \cdot [\text{NO}_2]^n \quad (3-2)$$

Such an expression describing how the rate of reaction depends on the concentration of reactant is called a rate expression. The proportionality constant k is called the rate constant and n is called the order of reaction which always must be determined from experimental data. The order of reaction may be positive as well as negative as well as an integer or e fraction. In general rate expressions are studied under conditions where n is either 0, 1 or 2, because there are analytical solutions for different time values t and values for the parameter k . When n is 0, the reaction is called a zero order reaction, while we have a first order and second order reaction when n is 1 or 2 respectively. The following things are worth noting concerning equation (3-2):

- Product concentration does not take part of the rate expressions because the rate of reaction is studied under conditions that do not contribute to the overall rate of reaction.
- The value of the order of reaction n must always be determined from experimental data and not be found from the reaction equation.

Example 3- D:*Order of reaction and rate expressions*

For 1. order reactions, where n equals 1, the general rate expressions for the use of reactant A may be expressed as:

$$\text{Rate for the use of A} = -\frac{d[A]}{dt} = k \cdot [A]^n = k \cdot [A], \quad n = 1$$

This differential equation may be solve analytically and it may be shown that the concentration of reactant A depends on the initial concentration of A (symbolised by $[A]_0$), rate constant k and time t in the following manner:

$$[A] = [A]_0 \cdot \exp(-k \cdot t)$$

For 2. order reactions where the parameter n is 2 a similar expression for the use of reactant A is:

$$\text{Rate of reaction for the use of A} = -\frac{d[A]}{dt} = k \cdot [A]^n = k \cdot [A]^2, \quad n = 2$$

Analogously, one achieves by the solution of this differential equation for the concentration of A:

$$\frac{1}{[A]} = k \cdot t + \frac{1}{[A]_0}$$

For the cases where the order of reaction is zero the following expression is achieved:

$$\text{Rate of reaction for the use of A} = -\frac{d[A]}{dt} = k \cdot [A]^n = k, \quad n = 0$$

For a zeroth order reaction the rate of reaction is constant and does not depend of the concentration of reactant. By integration one achieves simply the following expression for the concentration of A as function of time, the parameter k as well as the initial concentration $[A]_0$:

$$[A] = -k \cdot t + [A]_0$$

3.4 Chemical kinetics and catalysts

After the introduction of rate of reaction we have seen how a chemical reaction depends of other things than stoichiometry. It is thereby reasonable to assume that the temperature also plays a significant role for the cause and velocity of reaction. This combination is described by the Arrhenius-equation named after the Swedish chemist Svante Arrhenius due to his work on reaction kinetics in the 1880'ies. The Arrhenius-equation gives the connection between temperature, reaction constant and the concentration of reactant in the following manner:

$$\ln(k) = -\frac{E_a}{R} \frac{1}{T} + \ln(A) \quad (3- 3)$$

in which R is a universal constant called the gas constant and T is the temperature in Kelvin (absolute temperature). The parameter E_a is called the energy of activation. One can imagine that if a reaction should take place the reactants must collide and become products. This requires a certain amount of energy as there is a barrier to be overcome if the reactants should become products. The parameter E_a may be seen as the magnitude of this barrier. Does E_a have a large value it is difficult to make the products whereas it is easy to obtain the products if E_a has a small value. In the following example we shall look at a case where a value of E_a can be calculated using the Arrhenius-equation.

Please click the advert



Read The Spanner online on oxygen.ie

Download free books at BookBooN.com

Example 3- E:*Energy of activation*

The following gas phase reaction has been studied under different conditions:

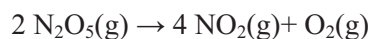

The rate constant k for a temperature of 30 °C is determined to be $7.3 \cdot 10^{-5} \text{ s}^{-1}$ and for a temperature of 60 °C determined to be $2.9 \cdot 10^{-3} \text{ s}^{-1}$. The value of E_a is to be determined.

We set-up the following expression on the basis of equation 3-3. For a temperature of 30 °C we have:

$$\ln(7.3 \cdot 10^{-5}) = -\frac{E_a}{R} \frac{1}{(273.15 + 30)} + \ln(A)$$

And for a temperature of 60 °C:

$$\ln(2.9 \cdot 10^{-3}) = -\frac{E_a}{R} \frac{1}{(273.15 + 60)} + \ln(A)$$

By subtracting the first expression from the last we obtain the equation:

$$\ln\left(\frac{2.9 \cdot 10^{-3}}{7.3 \cdot 10^{-5}}\right) = \frac{E_a}{8.314} \left(\frac{1}{(273.15 + 30)} - \frac{1}{(273.15 + 60)} \right) \Leftrightarrow E_a = 1.0 \cdot 10^5 \text{ J/mol}$$

Because the rate of reaction in general is highly affected by temperature one could believe that it was sufficient to either just turn up or turn down the temperature in order to let the desired reaction proceed as fast as possible. As well-known from many chemical processes e.g. from household cooking a number of reaction do run faster the higher temperature. Nevertheless one cannot always just increase the temperature. As an example, many of the vital functions in the human body are highly sensitive for changes in temperature. Further is it in addition often costly to increase the temperature industrially. Which other possibilities are there then? Catalysts are the solution to many problems in which it is necessary to increase the rate of reaction without having to increase the temperature. A catalyst is a chemical specie that makes a chemical reaction occur without being used itself in the reaction.

How do catalysts work? As mentioned earlier, it is required that reactants overcome a certain energy barrier before they can become products. One can imagine that what the catalyst does is to bring the height of the barrier down making it easier for the reaction to proceed. This means in other words that the rate of reaction is increased.

Catalysts are divided into two classes; homogenous and heterogeneous. A homogenous catalyst is one that may be found in same type of phase as the species that the catalyst helps to react. A heterogeneous catalyst

exists on the contrary in another phase (typically in solid form) than the species that it helps to react. Heterogeneous catalyst often involves that reactants on gas form is adsorbed on the surface of the solid catalyst material. Homogenous catalysts exist typically in either liquid or gas phases and are commonly found in nature.

Example 3- F:

Enzymes – catalysts of nature

Some of the most advanced homogenous catalysts are found in nature where they, in form of enzymes, help numerous processes vital for plants and life. Enzymes are large molecules with specific properties optimised typically on one chemical reaction. Enzymes are typically proteins and enzymes are used in many products in daily life as part of detergents, animal feed, industrial baking, dairy industries and more.

Enzymes are attractive to companies in the chemical industry as enzymes often tend to be less harmful to the environment than other types of catalysts. Unfortunately enzymes are sensitive molecules that often must have special temperatures and pH-conditions to function properly. You may find more information on enzymes at www.biosite.dk.

3.5 Kinetics of radioactive decay

We saw in section 1.1.1, how atoms with identical atom number but with different amount of neutrons are called isotopes. Likewise did we see that the combined number of protons and neutrons are called nucleons and that radioactive species decay under emission of different types of radiation. The rate of such decay is in principle similar to the rate of reaction for the transition of reactants to products in a chemical reaction. We imagine that for a specific time $t = 0$ we have an amount of specie with N_0 radioactive nuclei. It has been found that all nuclei have a specific probability of decaying within the next second. If this probability is e.g. 1/100 pr. second this means that on an average 1% of all nuclei decay each second. The number of radioactive nuclei is thereby a decreasing function with time and may formally be written as $N(t)$. The rate for the average number of decays pr. time is thereby defined analogously to equation (3-1) as:

$$\text{Rate of decay} = -\frac{\Delta N}{\Delta t} \rightarrow -\frac{dN}{dt} \quad (3-4)$$

in which the minus sign indicates that the number of radioactive nuclei is decreasing due to the decay. The fraction in equation (3-4) is called the activity and is denoted $A(t)$. The unit for the activity is s^{-1} as it indicates the number of decays pr. time but often the unit for radioactivity is called *Becquerel*. The probability that a certain nucleus decays within a certain time interval is denoted by the constant k called the constant of decay. Thereby equation (3-4) may be written as:

$$\text{Rate of decay} = -\frac{dN}{dt} = k \cdot N(t) = A(t) \quad (3-5)$$

By integration it may be shown that $N(t)$ depends of the constant of decay k , time t and the number of radioactive nuclei initially N_0 as:

$$N(t) = N_0 \cdot \exp(-k \cdot t) \quad (3-6)$$

3.5.1 Half-life

The half-life indicates how long it takes before the activity is decreased to half of the initial level. It is denoted by $t_{1/2}$ and given by:

$$t_{1/2} = \frac{\ln 2}{k} \quad (3-7)$$

The half-life for radioactive nuclei varies significantly from one species to another. E.g. has the Uranium-isotope ^{238}U a half-life of ca. 4.5 billion years whereas the bismuths isotope ^{214}Bi has a half-life of only roughly 20 minutes.

Is the half-life known it is possible to calculate a value for the decay constant k which thereby may be used in calculations of the activity and the number of radioactive nuclei to a given time.

Please click the advert

WHAT'S MISSING IN THIS EQUATION?

You could be one of our future talents

MAERSK INTERNATIONAL TECHNOLOGY & SCIENCE PROGRAMME

Are you about to graduate as an **engineer** or **geoscientist**? Or have you already graduated?
If so, there may be an exciting future for you with A.P. Moller - Maersk.



MAERSK

www.maersk.com/mitas

Example 3- G:*Radon in the cellar!*

Radon is a gas-specie that is formed by the solid radioactive element *radium* there is found all over in the earth in different amounts. Radon is radioactive and can be found in measurable amounts in our houses typically in the cellar. Radon penetrates into building primarily through the underground through cracks in the building fundament.

In a concrete cellar an activity from radon of 200 Becquerel from 1 m³ of air has been measured. If the cellar walls are isolated such that no new radon is added from the walls and floor the activity will decrease with time. As the half-life for radon-222 is 3.82 days the activity after this period will be 100 Becquerel. After further 3.82 days the activity will be 50 Becquerel.

We wish to determine how long it takes before the activity is decreased to 10 Becquerel. As we know the half-life we begin by calculating the decay constant k :

$$k = \frac{\ln 2}{3.82 \text{ dage}} = 0.181 \text{ dage}^{-1}$$

And hereby we achieve from equation (3- 6):

$$\begin{aligned} A(t) &= A_0 \cdot \exp(-k \cdot t) \Rightarrow \\ 10 \text{ Becquerel} &= 200 \text{ Becquerel} \cdot \exp(-0.181 \text{ dage}^{-1} \cdot t) \Rightarrow t = 16.6 \text{ dage} \end{aligned}$$

It thereby takes 16.6 days before the activity of radon is decreased to a value of 10 Becquerel.

Example 3- H:*Carbon-14 as a method to determine age*

A method to determine age on old items is the carbon-14 method that is based on the principles behind decay of the radioactive carbon-14 isotope. Items found in the Lascaux-caves in France have a rate of decay of ^{14}C nuclei of 2.25 pr. minute pr. gram carbon.

We wish to determine how old such items from the caves are. Half-life for ^{14}C is 5730 years. In living organisms 15.3 nuclei ^{14}C decay each minute pr. grams of carbon.

We exploit that decay, as earlier described, happens exponentially and that this may be expressed as:

$$\ln\left(\frac{A}{A_0}\right) = -k \cdot t,$$

where k can be expressed in terms of the half-life as:

$$k = \frac{\ln 2}{t_{1/2}}$$

We thereby arrive at:

$$\ln\left(\frac{2,25}{15,3}\right) = -\left(\frac{\ln 2}{5730 \text{ år}}\right) \cdot t \Leftrightarrow t = 15846 \text{ år}$$

The items found in the Lascaux-caves in France thereby has an approximate age of 15846 years.

3.6 Summing up on chapter 3

In this chapter we first saw how the chemical reaction equation must be written in terms of certain principles and rules; the stoichiometry must be fulfilled on both the right and the left side of the reaction arrow. We further saw through examples how reaction rate is a central term for the application of chemistry in practice. Expressions for rate of reactions were defined and we saw how rate of reaction not always is a constant parameter but often decreases with time. Further, the expression for the reaction rate was introduced with corresponding orders of reaction and rate constant. It was seen how the concentration of reactant clearly depended on the reaction order and expressions for 1., 2, and 0th order reactions was developed. The importance of temperature was highlighted via the introduction of the Arrhenius-equation with corresponding energy of activation. The term catalysts was briefly introduced by which it was described how catalysts may increase the rate of reaction (by lowering the energy of activation) of a chemical reaction without being consumed itself. Lastly, we saw how kinetics of radioactive decay in many ways is similar the kinetics for other chemical reactions. We looked at half-life and activity and via examples on how radioactive decay may be used to determine age of different old organic items.



www.job.oticon.dk

oticon
PEOPLE FIRST

4. Equilibrium

Solubility and equilibrium are closely connected and central terms in chemistry. In this section we shall look at equilibrium when solid species are dissolved in water. We will start by introducing basic terms as solubility and product of solubility.

4.1 Solubility equilibrium and solubility product

When a solid ionic compound is dissolved in water it is often assumed that the compound is completely separated into an anion and a cation. As example we look at the dissolution of solid calcium fluoride in water:

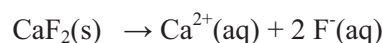

When CaF_2 are brought in contact with water there are initially no Ca^{2+} and F^{-} ions present. As the dissolution proceed the concentration of Ca^{2+} and F^{-} ions increase and with increasing concentration the probability that the opposite reaction occurs increases as well, being that the ions collide and once against forms solid CaF_2 following the reaction scheme below:



At last a dynamic equilibrium between the two reactions exist which is written as:

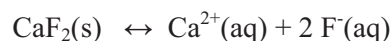

When the equilibrium occurs there is not more of the solid specie and the solution is said to be satisfied. We may write an equilibrium equation for this condition in the following manner:

$$K_{\text{sp}} = [\text{Ca}^{2+}] \cdot [\text{F}^{-}]^2$$

where $[\text{Ca}^{2+}]$ and $[\text{F}^{-}]$ are the concentrations of ions expressed in moles/L. The constant K_{sp} is called the *solubility constant* for the equilibrium. The reason that the solid specie CaF_2 is not included in the equilibrium expression is that solid species have an activity of 1. Solid species is thereby never included in equilibrium expressions even though it may seem strange that the amount of solid specie does not have any importance for the solution.

Example 4- A:*Calculation of solubility of PbSO₄*

We wish to calculate the solubility of lead sulphate PbSO₄ at 25 °C. At 25 °C PbSO₄ has a solubility constant of $1.3 \cdot 10^{-8} \text{ M}^2$. When solid PbSO₄ dissolves initially the system only contains PbSO₄(s) and H₂O but as time goes the solid specie will dissolve following the reaction scheme below:

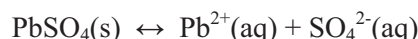

Due to the equilibrium reaction scheme the equilibrium expression may be written as:

$$K_{\text{sp}} = [\text{Pb}^{2+}] \cdot [\text{SO}_4^{2-}]$$

To determine the solubility of PbSO₄ it is necessary first to find the equilibrium concentrations of Pb²⁺ and SO₄²⁻. This may be done by specifying the initial concentrations (prior to any dissolution of lead sulphate) followed by a definition of the changes that are needed in order to reach equilibrium. As we in this case do not know the solubility we assume that x moles/L of the solid specie is to be dissolved in order to reach equilibrium. The scheme of reaction indicates 1:1 stoichiometry which is why we have:



By substitution of the equilibrium concentrations into the expression for K_{sp} we achieve:

$$1.3 \cdot 10^{-8} \text{ M}^2 = K_{\text{sp}} = [\text{Pb}^{2+}] \cdot [\text{SO}_4^{2-}] = x \cdot x \Leftrightarrow x = \sqrt{K_{\text{sp}}}$$

By which we get $x = 1.1 \cdot 10^{-4} \text{ M}$. Thus, the solubility of lead sulphate PbSO₄ at 25 °C is $1.1 \cdot 10^{-4} \text{ moles/L}$.

It is very important to distinguish between solubility of a solid specie and the product of solubility. Whereas the product of solubility is an equilibrium constant and thereby only has one value at a certain temperature, solubility is an equilibrium position which has an infinity of possible values at a given temperature depending on other factors such as the presence on foreign ions and more. The solubility product and the solubility of ions do also have different units which is why they cannot be readily compared.

4.1.1 Relative solubility

A solid species solubility constant K_{sp} gives important information about the species solubility. This is very convenient in a situation where only the solid specie is to be dissolved. K_{sp} values are often easy to find in literature. Are several solid species about to go into solution, the solubility product cannot be used in similar manner as earlier described. In principle one may imagine two situations, both of which we are going to look further into in the following examples. In one of the situations two or more solid species are about to go into solution where the solid species produce the same amount of ions. In the other situation there is likewise two or more different solid species but this time they produce a different amount of ions.

Example 4- B:*Relative solubility; first example*

We wish to determine the order of solubility of three solid species. In other words we wish to investigate which of the three following species that are easiest to dissolve:

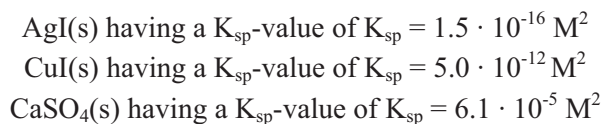

These three solid species give upon dissolution all two ions following the reaction schemes:

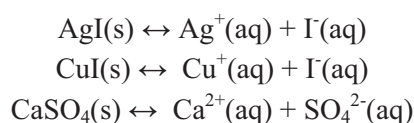

Or expressed more generally:

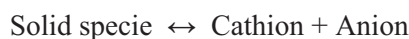

$$K_{\text{sp}} = [\text{Cathion}] \cdot [\text{Anion}]$$

If we assume that the solubility of cation as well as anion is x moles/L at equilibrium we achieve:

$$\begin{aligned} [\text{Cathion}] &= x \text{ mol/l} \\ [\text{Anion}] &= x \text{ mol/l} \end{aligned}$$

And thereby by insertion in the expression for K_{sp} :

$$\begin{aligned} K_{\text{sp}} &= [\text{Cathion}] \cdot [\text{Anion}] = x^2 \Leftrightarrow \\ x &= K_{\text{sp}}^{1/2} = \text{solubility} \end{aligned}$$

Thus, from the K_{sp} -values from above:

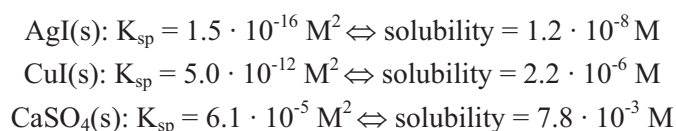

CaSO_4 is thereby most dissolvable followed by CuI and lastly AgI . In that the number of ions for the three different ions are the same (all include 2 ions) the product of solubility have the units of (M^2). Therefore in this case you may determine the order of dissolubility just by looking at the sizes of the solubility products (K_{sp}).

Please note that this is only possible when the units for K_{SP} are similar.

As mentioned in the prior example the order of solubility is determined by looking at the sizes of the solubility products only when these have the same units. In the following example we shall look at a situation where the order of solubility for three species is to be determined.

Example 4- C:

Relative solubility; second example

We wish to determine the order of solubility for the following three solid species:

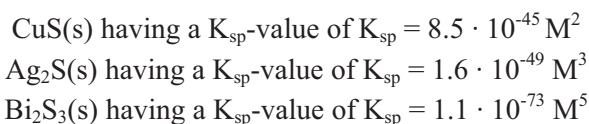

These three solid species give upon dissolution a different number of ions (which also may be seen from the different units for K_{sp}) following the reaction scheme:

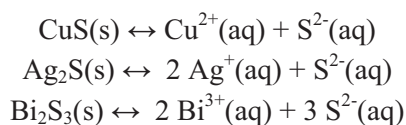

In order to determine the order of solubility a comparison of the K_{sp} values may not be used. On the contrary the solubility x for each of the species must be determined as sketched in a previous example:

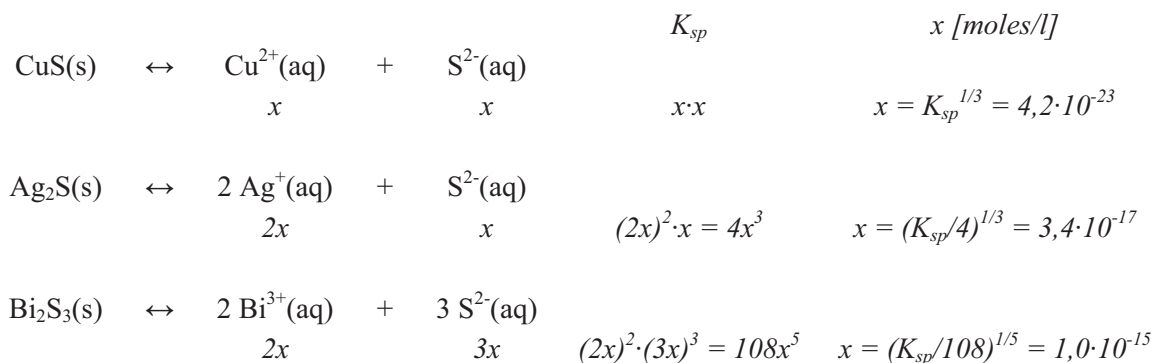

Now the order of solubility may be determined by comparing the sizes of the solubility x . Therefore Bi₂S₃ is most soluble followed by Ag₂S. Least soluble is CuS and this has thereby been sketched that when the number of ions in the species are different the sizes of K_{sp} cannot be used to determine the order of solubility.

4.1.2 Ion effects on solubility

So far we have only paid attention to ionic species and their solubility in pure water. In this section we shall look at how solubility is influenced by the presence of ions that one way or another also participates in the reaction of dissolution. This is something that we will look into in the following example:

Please click the advert



CHALLENGE YOURSELF

WWW.STUDYINSWEDEN.SE

Si.
Swedish Institute

Today's job market values ambitious, innovative, perceptive team players. Swedish universities foster these qualities through a forward-thinking culture where you're close to the latest ideas and global trends.

Whatever your career goals may be, studying in Sweden will give you valuable skills and a competitive advantage for your future. www.studyinsweden.se

Download free books at BookBooN.com

Example 4- D:*Solubility and foreign ions*

We wish to determine the solubility of silver chromate Ag_2CrO_4 in a 0.100 M aqueous solution of AgNO_3 . Silver chromate has a solubility product of $K_{\text{sp}} = 9.0 \cdot 10^{-12} \text{ M}^3$. before the solid silver chromate is dissolved there is already Ag^+ and NO_3^- ions present in the solution. As NO_3^- does not participate in the dissolution reaction for silver chromate, we may ignore this ion. The initial concentration of Ag^+ of 0.100 M has nevertheless an importance. We have the following initial concentrations:

$$\begin{aligned} [\text{Ag}^+]_0 &= 0.100 \text{ M} \\ [\text{CrO}_4^{2-}]_0 &= 0 \end{aligned}$$

The solubility concentration for silver chromate is as follows:



With corresponding equilibrium expression:

$$K_{\text{sp}} = [\text{Ag}^+]^2 \cdot [\text{CrO}_4^{2-}] = 9.0 \cdot 10^{-12} \text{ M}^3$$

We assume as often that x moles/L of $\text{Ag}_2\text{CrO}_4(\text{s})$ should be dissolved in order to reach equilibrium:



Equilibrium concentrations may be specified as:

$$\begin{aligned} [\text{Ag}^+]_0 &= [\text{Ag}^+]_0 + 2x = 0.100 \text{ M} + 2x \text{ M} \\ [\text{CrO}_4^{2-}] &= [\text{CrO}_4^{2-}]_0 + x = 0 + x \text{ M} \end{aligned}$$

By substitution into the equilibrium expression:

$$\begin{aligned} 9.0 \cdot 10^{-12} \text{ M}^3 &= [\text{Ag}^+]^2 \cdot [\text{CrO}_4^{2-}] = (0.100 + 2x)^2 \cdot x \Leftrightarrow \\ x &= 9.0 \cdot 10^{-10} \text{ M} \end{aligned}$$

There may thereby be dissolved $9.0 \cdot 10^{-10} \text{ mol/L Ag}_2\text{CrO}_4(\text{s})$ in 0.100 M AgNO_3 . It is easy to realise that had we had a pure water solution, the solubility would have been found by the following equation:

$$\begin{aligned} 9.0 \cdot 10^{-12} \text{ M}^3 &= [\text{Ag}^+]^2 \cdot [\text{CrO}_4^{2-}] = (2x)^2 \cdot x \Leftrightarrow \\ x &= 1.3 \cdot 10^{-4} \text{ M} \end{aligned}$$

Thus, there may be dissolved $1.3 \cdot 10^{-4} \text{ moles/L Ag}_2\text{CrO}_4(\text{s})$ in pure water. It may thereby been seen that by comparison of the aqueous solution with the 0.100 M AgNO_3 solution that there may be dissolved far more $\text{Ag}_2\text{CrO}_4(\text{s})$ in pure water then in the solution containing Ag^+ ions already present. One may in an informal way say that the silver ions already present in the solution hinder the dissolution of silver chromate.

4.2 Precipitation

So far we have only looked at the dissolution of solid species in aqueous solutions with or without an initial concentration of ions. In this section we will look at the opposite process which is precipitation of solid material. We will look at the situation where two solutions are mixed by which a possibility arise for solid matter to precipitate. For this purpose we will use the so-called ion product which is defined in a similar manner as we defined the solubility product K_{sp} except that in the expression for the ion product the initial concentrations participate. For our example with CaF_2 the ion product is defined as:

$$Q = [\text{Ca}^{2+}]_0 \cdot [\text{F}^-]_0^2$$

If we pour a solution of Ca^{2+} ions into a solution containing F^- ions a possibility arise for the precipitation of solid CaF_2 depending on the respective concentrations. In order to be able to predict a possible precipitation we will look at the relation between K_{sp} and Q . The units for K_{sp} and Q are thereby identical which is why the two parameters may be compared readily. In general:

- Is the value of Q larger than K_{sp} , precipitation will take place and this precipitation will continue until the concentrations of remaining ions in the solution will fulfil the equation for K_{sp} , and then $Q=K_{sp}$.
- Is the value of Q less than K_{sp} ; no precipitation will take place.

Often it is desired to determine more precisely whether or not a precipitation will take place because we want to determine the equilibrium concentration after precipitation. This is the topic for the next example.

Please click the advert

Always aiming for higher ground. Just another day at the office for a Tiger.

Join the Accenture High Performance Business Forum

On Thursday, April 23rd, Accenture invites top students to the High Performance Business Forum where you can learn how leading Danish companies are using the current economic downturn to gain competitive advantages. You will meet two of Accenture's global senior executives as they present new original research and illustrate how technology can help forward thinking companies cope with the downturn.

Visit student.accentureforum.dk to see the program and register

Visit student.accentureforum.dk

• Consulting • Technology • Outsourcing

High performance. Delivered.

© 2009 Accenture. All rights reserved.

Example 4- E:

Equilibrium concentration after precipitation of lead nitrate (PbNO₃)

We wish to determine the equilibrium concentrations of Pb²⁺ and I⁻ ions formed after precipitation of PbI₂ in a solution formed by mixing 100.0 mL of a 0.0500 M Pb(NO₃)₂ solution and 200.0 mL of a 0.100 M NaI solution.

Initially it must be determined whether or not solid PbI₂ is formed during the mixing of the solutions. The solubility product K_{sp} for PbI₂ is $1.4 \cdot 10^{-8} \text{ M}^3$. The concentrations of Pb²⁺ and I⁻ after the mixing is easily achieved as:

$$[Pb^{2+}]_0 = \frac{0.100L \cdot 0.0500 \text{ mol/L}}{0.300L} = 1.67 \cdot 10^{-3} \text{ M} \quad \text{and}$$

$$[I^-]_0 = \frac{0.200L \cdot 0.100 \text{ mol/L}}{0.300L} = 6.67 \cdot 10^{-2} \text{ M}$$

Hereby the ion product for PbI₂ is determined as:

$$Q = [Pb^{2+}]_0 \cdot [I^-]_0^2 = 1.67 \cdot 10^{-3} \text{ M} \cdot (6.67 \cdot 10^{-2} \text{ M})^2 = 7.43 \cdot 10^{-5} \text{ M}^3$$

As in this case Q is larger than K_{sp} precipitation of PbI₂(s) will happen. In order to determine the concentrations of Pb²⁺ and I⁻ ions after precipitations, we set up initially a *before* and an *after* scheme on the basis of moles following the principles below:

	Pb ²⁺ (aq)	+ 2 I ⁻ (aq)	→ PbI ₂ (s)
Before precipitation:	0.100 L · 0.0500 mol/L = 5.0 · 10 ⁻³ mol	0.200 L · 0.100 mol/L = 2.0 · 10 ⁻² mol	The amount of precipitated matter will
After precipitation:	0 mol	2.0 · 10 ⁻² mol – 5.0 · 10 ⁻³ mol = 1.0 · 10 ⁻² mol	not affect the equilibrium

Now we let the equilibrium take place. At equilibrium the concentration of [Pb²⁺] is not zero as indicated above because the precipitation reaction does not proceed until all the lead ions are used. One may imagine that when PbI₂ precipitated a small amount of PbI₂ is simultaneously dissolved such that an equilibrium is set up. As there is an excess of I⁻ ions the small amount of re-dissolved PbI₂ is dissolved into a solution containing 1.0 · 10⁻² mol I⁻ in 300.0 mL solution. This gives a concentration of I⁻ of:

$$[I^-] = \frac{1.0 \cdot 10^{-2} \text{ mol/L}}{0.300L} = 3.33 \cdot 10^{-2} \text{ M}$$

Hereafter our problem may be formulated as: What is the solubility of solid PbI₂ in a 3.33 · 10⁻² M NaI solution? As earlier examples we start by writing the initial concentrations:

$$[\text{Pb}^{2+}]_0 = 0 \text{ M}$$
$$[\text{I}^-]_0 = 3.33 \cdot 10^{-2} \text{ M}$$

The end concentrations is found on the basis of the reaction scheme:

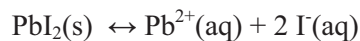

$$[\text{Pb}^{2+}] = x$$
$$[\text{I}^-] = 3.33 \cdot 10^{-2} \text{ M} + 2x$$

And by insertion into the expression for K_{sp} in the equation we achieve:

$$K_{\text{sp}} = 1.4 \cdot 10^{-8} \text{ M}^3 = [\text{Pb}^{2+}] \cdot [\text{I}^-] = x \cdot (3.33 \cdot 10^{-2} \text{ M} + 2x)^2 \Leftrightarrow$$
$$x = 1.3 \cdot 10^{-5} \text{ M}$$

Thus, the equilibrium concentrations become:

$$[\text{Pb}^{2+}]_{\text{equilibrium}} = 1.3 \cdot 10^{-5} \text{ M}$$
$$[\text{I}^-]_{\text{equilibrium}} = 3.33 \cdot 10^{-2} \text{ M} + 2x \approx 3.33 \cdot 10^{-2} \text{ M}$$

Thereby we have determined the equilibrium concentrations of lead and iodine ions in a solution that is prepared by mixing solutions of sodium iodine and lead.

4.2.1 Selective precipitation

Solutions of metal ions are often separated by selective precipitation which is precipitation with a reagent having an anion that forms a solid specie with only one of the metal ions in the solution. One example is a solution with Ba^{2+} ions as well as Ag^+ ions. Are NaCl added to the solution only AgCl precipitates whereas Ba^{2+} ions continues to be in the solution, as BaCl is easily soluble. This we will look further into in the following example.

Example 4- F:

Selective precipitation

A solution contains $1.0 \cdot 10^{-4}$ M Cu^+ ions and $2.0 \cdot 10^{-3}$ M Pb^{2+} ions. We now slowly add a aqueous solution containing I^- ions. Hereby, $\text{PbI}_2(\text{s})$ precipitates following the reaction scheme below:

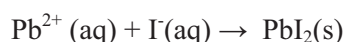

The K_{sp} values are $1.4 \cdot 10^{-8} \text{ M}^3$ for PbI_2 and $5.3 \cdot 10^{-12} \text{ M}^2$ for CuI respectively. We now wish to determine which one of the two solid species that precipitates first. Furthermore we wish to determine the concentration of I^- being necessary to precipitate each of the two solid species.

For PbI_2 the expression for K_{sp} is:

$$1.4 \cdot 10^{-8} \text{ M}^3 = K_{\text{sp}} = [\text{Pb}^{2+}] \cdot [\text{I}^-]^2$$

As we know that the concentration of Pb^{2+} is $2.0 \cdot 10^{-3}$ M the largest possible concentration of I^- being able to exist without precipitation may be calculated from:

$$1.4 \cdot 10^{-8} \text{ M}^3 = K_{\text{sp}} = [\text{Pb}^{2+}] \cdot [\text{I}^-]^2 = (2.0 \cdot 10^{-3}) \cdot [\text{I}^-]^2 \Leftrightarrow \\ [\text{I}^-] = 2.6 \cdot 10^{-3} \text{ M}$$

A concentration of I^- ions above $2.6 \cdot 10^{-3}$ M will thereby lead to precipitation of $\text{PbI}_2(\text{s})$. Similarly for CuI :

$$5.3 \cdot 10^{-12} \text{ M}^2 = K_{\text{sp}} = [\text{Cu}^+] \cdot [\text{I}^-] = (1.0 \cdot 10^{-4}) \cdot [\text{I}^-] \Leftrightarrow \\ [\text{I}^-] = 5.3 \cdot 10^{-8} \text{ M}$$

Thus, a concentration of I^- ions higher than $5.3 \cdot 10^{-8}$ M will lead to precipitation of $\text{CuI}(\text{s})$. On the basis of these calculations we can thereby settle which of the two solid species that will precipitate first. Are I^- ions added gradually $\text{CuI}(\text{s})$ will precipitate first whereby Cu^+ may be separated from Pb^{2+} using this principle.

4.3 Summing up on chapter 4

Central terms as solubility product and solubility equilibrium were introduced in this chapter. Through examples we saw how solubility may be calculated from information of solubility constants. Further we saw how the relative solubility of solid species may be determined on the basis of such constants.

An order of solubility of different solid species may be determined by looking at the solubility product K_{sp} ONLY when the numbers of ions are similar (meaning ONLY when the K_{sp} parameters have the same unit). When the number of ions in the solid species are different the order of solubility must be determined by calculating the solubility x in moles pr. litre as the solubility products K_{sp} do not have a similar unit and thereby may not be compared.

As one of the more advanced examples we saw how the presence of foreign ions may influence the solubility of solid species but that it is still possible to calculate the solubility. Lastly, we looked at precipitation and here also introduced the ion product. We saw how the relation between the ion product and the solubility constant determined whether or not precipitation will take place or not. This was further illustrated through examples concerning selective precipitation.

Please click the advert





it's an **interesting** world

Get under the skin of it.

Graduate opportunities
Cheltenham | £24,945 + benefits

One of the UK's intelligence services, GCHQ's role is two-fold: to gather and analyse intelligence which helps shape Britain's response to global events, and, to provide technical advice for the protection of Government communication and information systems. In doing so, our specialists – in IT, internet, engineering, languages, information assurance, mathematics and intelligence – get well beneath the surface of global affairs. If you thought the world was an interesting place, you really ought to explore our world of work.

www.careersinbritishintelligence.co.uk

Applicants must be British citizens. GCHQ values diversity and welcomes applicants from all sections of the community. We want our workforce to reflect the diversity of our work.







5. Acids and bases

In this chapter we shall look at central parts of chemistry being acid and base chemistry. We will look at their interactions and further develop the theory of equilibrium introduced in the previous section. Large parts of the fundamental knowledge of acids and bases were thoroughly introduced in the high-school meaning that we will look at more advanced theory here. We start by mentioning that acid/base chemistry always takes place in aqueous solutions. Terms as *acid strength* and *base strength* have thereby only relevance in connection of aqueous solutions.

5.1 About acids and bases

Acid solutions are known from many types of foods. According to the famous Brønsted-Lowry definition an acid is a proton donor (in terms of H^+ ions), while a base is a proton receiver (water may act as an acid as well as act as a base).

In an acid-base reaction a H^+ ion is transferred from the acid to the base following the principle below where the acid is written in general as HA while the corresponding base is written as A^- :



By transfer of the H^+ ion the acid HA is converted to its corresponding base A^- . Thus, HA and A^- is a corresponding acid/base pair.

5.1.1 Acid strength

The strength of an acid solution is defined on the basis of the position of the following equilibrium where the acid in general is written as HA while the corresponding base is written as A^- :



An acid is known to be strong when the equilibrium is strongly shifted to the right meaning that there is almost no HA left in the solution. On the contrary the acid is known to be weak when there is almost no corresponding base A^- in the solution. When the acid is strong the equilibrium arrow may be replaced by a right-pointing arrow but when the acid is weak the equilibrium arrow must be written.

An equilibrium expression for the general acid-base reaction may be expressed in a similar way as in chapter 3 and chapter 4:

$$K_a = \frac{[H_3O^+] \cdot [A^-]}{[HA]} = \frac{[H^+] \cdot [A^-]}{[HA]}$$

The equilibrium constant K_a , when we have an acid-base reaction, is known as the acids *dissociation-constant* or simply the strength-constant. Similarly is defined a dissociation-constant for bases K_b . We do not distinguish between H^+ and H_3O^+ ions in the following as long as one remembers that in aqueous solutions H^+ always exist as H_3O^+ ions. As the percent wise amounts of water molecules by far dominate the amount of acid-base components, the mole fraction of water is close to one. Water takes part of the equilibrium expressions with its mole fraction which is why it is often omitted in practice. Similarly corresponding to the considerations above it is clear that for strong acids the K_a values are large while K_a values are small for weak acids. As the K_a values vary a lot from acid to acid one has for the sake of convenience often chosen to express the acid constant in an acid *strength exponent* defined as:

$$pK_a = -\log[K_a] \quad (5-1)$$

Based on this definition it is obvious that strong acids gets a very small or even negative pK_a value while strong acids have pK_a values from approximately 10 and up.

5.1.2 The pH-scale

Because the concentration of H^+ ions in solution generally is quite small one has for the sake of convenience chose to express a solutions acidness based on the decimal logarithm to the concentration of H^+ ions completely analogous to the principles that the acid constant K_a was expressed as an acid exponent pK_a . this is known as the pH scale and the pH values are defined as:

$$pH = -\log[H^+] = -\log[H_3O^+] \quad (5-2)$$

This means that if a solution has a concentration of H^+ ions of e.g. $1.0 \cdot 10^{-7}$ M one would say that the pH value of the solution is 7. Figure 5-1 gives the pH-scale as well as pH-values for well-known aqueous solutions.

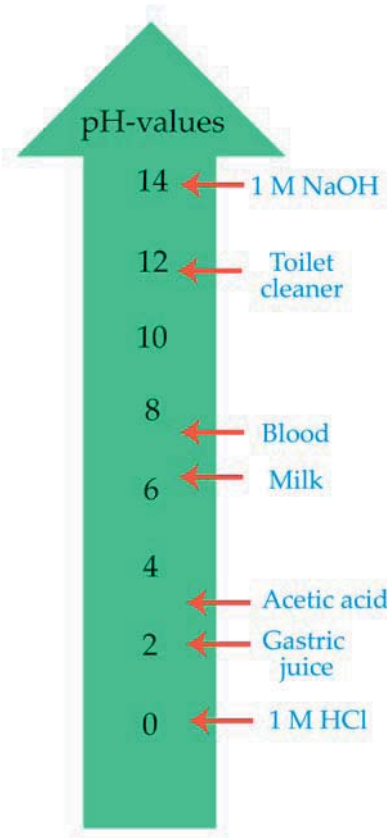

Figure 5- 1: The pH-scale

pH-values for well-known solutions.

Please click the advert

CHALLENGE YOURSELF

WWW.STUDYINSWEDEN.SE

Today's job market values ambitious, innovative, perceptive team players. Swedish universities foster these qualities through a forward-thinking culture where you're close to the latest ideas and global trends.

Si.
Swedish Institute

Whatever your career goals may be, studying in Sweden will give you valuable skills and a competitive advantage for your future. www.studyinsweden.se

Download free books at BookBooN.com

As pH is a logarithmic scale based on the decimal system means that the pH value of a solution is changed one unit for each time the $[H^+]$ is changed 10 times. E.g. does a solution with a pH-value of 4 have a concentration of H^+ ions 10 times as high as a solution with a pH value of 5.

5.1.3 The autoprotolysis of water

As indicated earlier water may function both as an acid and as a base. Such a property is often referred to as an amfolyte and water is an amfolyte. This means that water may react with it self in the following reaction:

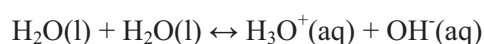

The equilibrium lies nevertheless far to the left. The equilibrium constant for the specific equilibrium is referred to as K_w having the following values.

$$K_w = 1,0 \cdot 10^{-14} M^2$$

This means that there are only relatively few water molecules that are transferred to H_3O^+ and OH^- ions. This equilibrium sets itself in pure water and in aqueous solutions. In pure water $[H_3O^+] = [OH^-]$ as the ions are produced in an 1:1 relation. At a temperature of 25 °C in pure water:

$$[H_3O^+] = [OH^-] = 1,0 \cdot 10^{-7} M$$

which is why pH thereby in pure water is $pH = 7,0$. This means that in pure water the concentration of H_3O^+ and OH^- respectively is in the order of 10^{-7} moles/L. If we later in order to determine the concentrations of H^+ or OH^- in acid and base solutions calculate concentrations in the range of 10^{-7} moles/L one may not neglect the effect of autoprotolysis of water. If instead we calculate concentrations of H^+ or OH^- in the range of 10^{-5} moles/L or larger we will often neglect the effect of autoprotolysis of water.

5.2 pH calculations

We will In the following section look at methods for calculating pH values in a number of different solutions.

5.2.1 Calculation of pH in strong acid solutions

Calculations of pH values in solutions are closely connected with the equilibrium considerations described in the previous chapter. As it is the case when equilibrium is considered one has to focus on components of the solution and its chemistry. This will be further looked into in the following example:

Example 5- A:*pH calculation in a strong acid (hydrochloric acid)*

A solution consists of 0.5 M HCL. We know that HCl is a strong acid which is why it is reasonable to assume that the acid is completely dissociated meaning that the following reaction is completely turned to the right:

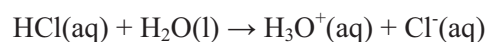

We neglect as it is often the case the contribution to the concentration of H_3O^+ from autoprotolysis of water and assume that all HCl molecules are dissociated which is why:

$$[\text{H}_3\text{O}^+] = 0,5 \text{ M}$$

Now the pH value is easily achieved as:

$$\text{pH} = -\log[\text{H}_3\text{O}^+] = -\log[0,5] = 0,3$$

5.2.2 Calculation of pH in weak acid solutions

As mentioned earlier it is necessary to account for the equilibrium in the case with weak acids. As the following example illustrate one has to proceed in steps when pH is to be calculated in weak acid solutions.

Please click the advert

Brain power

By 2020, wind could provide one-tenth of our planet's electricity needs. Already today, SKF's innovative know-how is crucial to running a large proportion of the world's wind turbines.

Up to 25 % of the generating costs relate to maintenance. These can be reduced dramatically thanks to our systems for on-line condition monitoring and automatic lubrication. We help make it more economical to create cleaner, cheaper energy out of thin air.

By sharing our experience, expertise, and creativity, industries can boost performance beyond expectations. Therefore we need the best employees who can meet this challenge!

The Power of Knowledge Engineering

Plug into The Power of Knowledge Engineering.
Visit us at www.skf.com/knowledge

SKF

Download free books at BookBooN.com

Example 5- B:*pH calculation in weak acid solution*

A solution consists of 1.0 M HF. HF has a K_a value of $7.2 \cdot 10^{-4}$ M and we thereby have a weak acid solution. We wish to calculate the pH-value of the solution.

The first step is to write the most important components in the solution which in this case is:



After this we write the aqueous equilibrium:

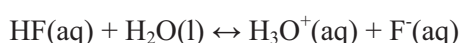

We return to the equilibrium expression which is written as:

$$K_a = 7,2 \cdot 10^{-4} \text{ M} = \frac{[\text{H}_3\text{O}^+] \cdot [\text{F}^-]}{[\text{HF}]}$$

Analogously to prior examples we now pay attention to initial and equilibrium conditions. The initial and end-concentrations are written and as in chapter 4 the parameter x gives the relations to the equilibrium concentrations.

$$\begin{aligned} [\text{HF}]_0 &= 1,0 \text{ M} \\ [\text{F}^-]_0 &= 0 \text{ M} \\ [\text{H}_3\text{O}^+]_0 &= 10^{-7} \text{ M (from the autoprotolysis of water)} \end{aligned}$$

And end-concentrations by:

$$\begin{aligned} [\text{HF}] &= (1,0 - x) \text{ M} \\ [\text{F}^-] &= x \text{ M} \\ [\text{H}_3\text{O}^+] &= (10^{-7} + x) \text{ M} \end{aligned}$$

which gives the following equation:

$$K_a = 7.2 \cdot 10^{-4} \text{ M} = \frac{(10^{-7} + x) \cdot x}{1.0 - x} \Rightarrow x = 2.6 \cdot 10^{-2} \text{ M}$$

Thereby $[\text{H}_3\text{O}^+] = 2,6 \cdot 10^{-2}$ M which is why the pH value in the solution becomes:

$$\text{pH} = -\log[\text{H}_3\text{O}^+] = -\log(2.6 \cdot 10^{-2}) = 1.6$$

It may be seen from the calculations that the contribution to the H_3O^+ concentration from the autoprotolysis of water is negligible compared to the calculated x . Thus, the contribution from the autoprotolysis of water may in practise be omitted when x is in the range of 10^{-5} mol/L or larger.

5.2.3 Calculation of pH in mixtures of weak acids

Sometimes a solution contains a mixture of two weak acids with different acid strengths. Calculations of pH in such solutions require some additional considerations. This will be illustrated in the following example.

Trust and responsibility

NNE and Pharmaplan have joined forces to create NNE Pharmaplan, the world's leading engineering and consultancy company focused entirely on the pharma and biotech industries.

Inés Aréizaga Esteva (Spain), 25 years old
Education: Chemical Engineer

– You have to be proactive and open-minded as a newcomer and make it clear to your colleagues what you are able to cope. The pharmaceutical field is new to me. But busy as they are, most of my colleagues find the time to teach me, and they also trust me. Even though it was a bit hard at first, I can feel over time that I am beginning to be taken seriously and that my contribution is appreciated.

Please click the advert



NNE Pharmaplan is the world's leading engineering and consultancy company focused entirely on the pharma and biotech industries. We employ more than 1500 people worldwide and offer global reach and local knowledge along with our all-encompassing list of services.
nnepharmaplan.com

nne pharmaplan®

Example 5- C:*pH in the solution with two weak acids*

We wish to determine pH in a solution containing 1.00 M HCN and 5.00 M HNO₂. From a table we have found that the K_a value for HCN is 6.2 · 10⁻¹⁰ M while the K_a value is 4.0 · 10⁻⁴ M for HNO₂. as both acids are weak acids, and thereby only partly dissociates, the primarily species in the solution are:



The following primary reactions may be written as:

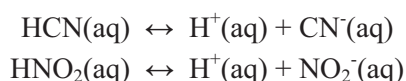

Such a mixture of two weak acids seems as a complex problem. As nevertheless HNO₂ from the K_a values is a far stronger acid than HCN (these may be directly compared as the K_a's have a similar unit), we will assume that this acid is the dominating contributor to H⁺ ions in the solution. We will thereby focus only on this equilibrium with corresponding equilibrium expression:



$$K_a = 4.0 \cdot 10^{-4} \text{ M} = \frac{[\text{H}^+] \cdot [\text{NO}_2^-]}{[\text{HNO}_2]}$$

We now look at initial and equilibrium conditions similar to other examples. The initial concentrations are:

$$\begin{aligned}[\text{HNO}_2]_0 &= 5.00 \text{ M} \\ [\text{NO}_2^-]_0 &= 0 \text{ M} \\ [\text{H}^+]_0 &= 10^{-7} \text{ M (from autoprotolysis of water)}\end{aligned}$$

and the end-concentrations are thereby:

$$\begin{aligned}[\text{HNO}_2]_0 &= (5.00 - x) \text{ M} \\ [\text{NO}_2^-]_0 &= x \text{ M} \\ [\text{H}^+]_0 &= (10^{-7} + x) \text{ M}\end{aligned}$$

which by insertion in the expression for K_a gives:

$$K_a = 4.0 \cdot 10^{-4} \text{ M} = \frac{(10^{-7} + x) \cdot x}{5.00 - x} \Rightarrow x = 4.5 \cdot 10^{-2} \text{ M}$$

The concentration of H⁺ ions is thereby 4.5 · 10⁻² M which gives a pH value of:

$$pH = -\log[4,5 \cdot 10^{-2}] = 1.35$$

Once again we see that the contribution to the H_3O^+ concentration from the autoprotolytic contribution of water is negligible compared to the calculated x -value why this contribution of 10^{-7} M in practice may be omitted.

5.3 Polyprotic acids

Some acids such as e.g. H_2SO_4 and H_3PO_4 may provide more than one H^+ ion. Such acids are called polyprotic acids, and these acids provide their H^+ ions in steps one proton at the time. For each step it is possible to determine a K_a value. The diprotic acid H_2CO_3 provide thereby its two protons in the following two steps with corresponding equilibrium expression:

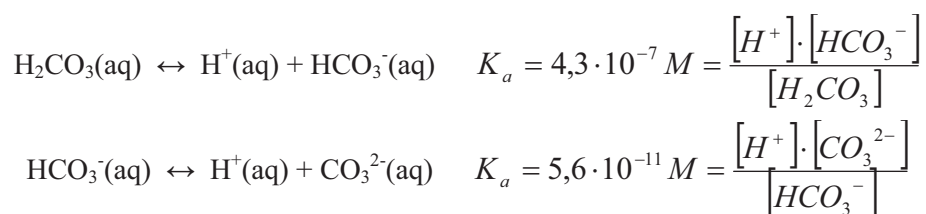

Please note how the corresponding base from the first step (hydrogen carbonate, HCO_3^-) becomes the acid in step number two. Such a property is characterised for an amfolyte. We shall see in the example below how pH may be calculated when we have a solution of a polyprotic acid.

Please click the advert

THE MILKWAY
LAUNCHING GRADUATE CAREERS

MILKROUND SYSTEM
Become a business star with internships, placements, graduate jobs & schemes from leading companies.
www.milkround.com

PLANET CAREER ADVICE
Inhabited by insights into business careers and orbited by application advice.

FIRST CONTACT
Get matched to top business employers via intelligent emails landing in your inbox.

Milkround.com: rated the #1 graduate recruitment website in the UK Graduate Careers Survey 2009 of 16,000 university finalists.

Milkround.com

Example 5- D:*pH in a solution of polyprotic acid*

We wish to determine the pH value in a 5.0 M H_3PO_4 solution. H_3PO_4 is a tri-protic acid being semi-strong in the first step. In the first case we will assume that the dominating components in the solution are:

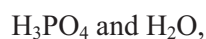

And initially the dominating step is:



This equilibrium corresponding equilibrium expression is:

$$K_{a1} = 7.5 \cdot 10^{-3} \text{ M} = \frac{[\text{H}^+] \cdot [\text{H}_2\text{PO}_4^-]}{[\text{H}_3\text{PO}_4]}$$

We will now look at the initial and equilibrium conditions analogously to other examples. The initial concentrations are:

$$\begin{aligned} [\text{H}_3\text{PO}_4]_0 &= 5.0 \text{ M} \\ [\text{H}_2\text{PO}_4^-]_0 &= 0 \text{ M} \\ [\text{H}^+]_0 &\approx 10^{-7} \text{ M (from the auto protolysis of water)} \end{aligned}$$

and the end-concentrations are thereby:

$$\begin{aligned} [\text{H}_3\text{PO}_4] &= (5.0 - x) \text{ M} \\ [\text{H}_2\text{PO}_4^-] &= x \text{ M} \\ [\text{H}^+] &= (10^{-7} + x) \text{ M} \end{aligned}$$

which by insertion into the expression for K_a gives:

$$K_{a1} = 7.5 \cdot 10^{-3} = \frac{[\text{H}^+] \cdot [\text{H}_2\text{PO}_4^-]}{[\text{H}_3\text{PO}_4]} = \frac{(10^{-7} + x) \cdot x}{5.0 - x} \Rightarrow x = 0.19 \text{ M}$$

The concentrations of H^+ ions is 0.19 M which gives a pH of:

$$\text{pH} = -\log[0.19] = 0.72$$

So far we have assumed that it is only the first step that participate significant to the H_3O^+ concentration and thereby the pH value. In order to verify that the second and third step do not contribute to the H_3O^+

concentration it is necessary with additional calculations of $[\text{HPO}_4^{2-}]$ and $[\text{PO}_4^{3-}]$ from the second and from the third step of equilibrium.

The concentrations of HPO_4^{2-} may be found in terms of the following equilibrium with corresponding expression of equilibrium:



$$K_{a2} = 6.2 \cdot 10^{-8} \text{ M} = \frac{[\text{H}^+] \cdot [\text{HPO}_4^{2-}]}{[\text{H}_2\text{PO}_4^-]}$$

where:

$$[\text{H}^+] \approx [\text{H}_2\text{PO}_4^-] = 0.19 \text{ M} \text{ (The autoprotolysis of water is neglected)} \rightarrow$$

$$[\text{HPO}_4^{2-}] = K_{a2} = 6.2 \cdot 10^{-8} \text{ M}$$

In order to calculate $[\text{PO}_4^{3-}]$ we use the third equilibrium step with corresponding equilibrium expression.



$$K_{a3} = 4.8 \cdot 10^{-13} \text{ M} = \frac{[\text{H}^+] \cdot [\text{PO}_4^{3-}]}{[\text{HPO}_4^{2-}]} \approx \frac{0.19 \text{ M} \cdot [\text{PO}_4^{3-}]}{6.2 \cdot 10^{-8} \text{ M}} \Leftrightarrow [\text{PO}_4^{3-}] = 1.6 \cdot 10^{-19} \text{ M}$$

It is seen from the equilibrium expressions that the concentrations of H_3O^+ and HPO_4^{2-} respectively simply are taken from the calculations in the first and second step. From the calculated values of $[\text{HPO}_4^{2-}]$ and $[\text{PO}_4^{3-}]$ both being very small it is reasonable to neglect these two acids contribution to the pH of the solution. The value of pH in solution seems thereby to be excellently approximated by the pH value of pH = 0.72.

5.4 Acid properties of salts

Some salts exhibit properties making solutions acid when the salt is dissolved in water. E.g., the following reaction takes place when NH_4Cl is dissolved in water:

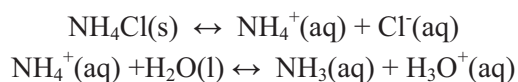

The last reaction is an acid-base reaction and we shall look at how pH is calculated in such a solution in the following example:

Example 5- E:*pH in a solution of aluminium chloride*

We wish to determine pH in a 0.01 M solution of AlCl_3 . It has been observed that when aluminium chloride is dissolved in water an acid solution is the result. Even though the Al^{3+} ion is not an acid itself as it cannot produce a H^+ ion, it is the so-called hydrate compound $\text{Al}(\text{H}_2\text{O})_6^{3+}$ that is a weak acid reacting with water in the following manner:



The aluminium-ion will thereby in aqueous solution be surrounded by 6 water molecules. The K_a value for $\text{Al}(\text{H}_2\text{O})_6^{3+}$ is $1.4 \cdot 10^{-5}$ M. Again we will start by looking at the main components in the solution. These are in this case:

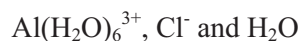

On the basis of the reaction scheme above we have the following equilibrium expression:

$$K_a = 1.4 \cdot 10^{-5} \text{ M} = \frac{[\text{H}_3\text{O}^+] \cdot [\text{Al}(\text{OH})(\text{H}_2\text{O})_5^{2+}]}{[\text{Al}(\text{H}_2\text{O})_6^{3+}]}$$

We will now look at start and equilibrium conditions completely similar to prior examples. The initial concentrations are:

$$\begin{aligned} [\text{Al}(\text{H}_2\text{O})_6^{3+}]_0 &= 0.01 \text{ M} \\ [\text{Al}(\text{OH})(\text{H}_2\text{O})_5^{2+}]_0 &= 0 \text{ M} \\ [\text{H}_3\text{O}^+]_0 &= 10^{-7} \text{ M (from the autoprotolysis of water)} \end{aligned}$$

and the end concentrations thereby become:

$$\begin{aligned} [\text{Al}(\text{H}_2\text{O})_6^{3+}] &= (0.01 - x) \text{ M} \\ [\text{Al}(\text{OH})(\text{H}_2\text{O})_5^{2+}] &= x \text{ M} \\ [\text{H}_3\text{O}^+] &= (10^{-7} + x) \text{ M} \end{aligned}$$

which by insertion in the expression for K_a gives:

$$K_a = 1.4 \cdot 10^{-5} \text{ M} = \frac{[\text{H}_3\text{O}^+] \cdot [\text{Al}(\text{OH})(\text{H}_2\text{O})_5^{2+}]}{[\text{Al}(\text{H}_2\text{O})_6^{3+}]} = \frac{(10^{-7} + x) \cdot x}{0.01 - x} \Rightarrow x = 3.7 \cdot 10^{-4} \text{ M}$$

Thus the concentrations of H_3O^+ ions is $3.7 \cdot 10^{-4}$ M by which pH becomes:

$$pH = -\log[3.7 \cdot 10^{-4}] = 3.4$$

Again we have for the completeness added the contribution to the H_3O^+ concentration for the autoprotolysis of water, even though this is negligible compared to the calculated x-value. In this case the contribution from the autoprotolysis may be neglected.

5.4 Ion effects on pH

We have in prior chapters seen how the presence of foreign ions may influence equilibrium. We shall in this section. We shall in this section quite similar look at how the presence of H_3O^+ ions may influence pH. E.g. will we look at a solution containing not just the weak acid (in general presented as HA), but also at the same time contains its salt (in general presented as NaA). Even though it may seem as if we now have a completely new type of problem it will in fact turn out to be a type of problem we can solve analogously to prior problems. This we will look into in the following example.

Please click the advert

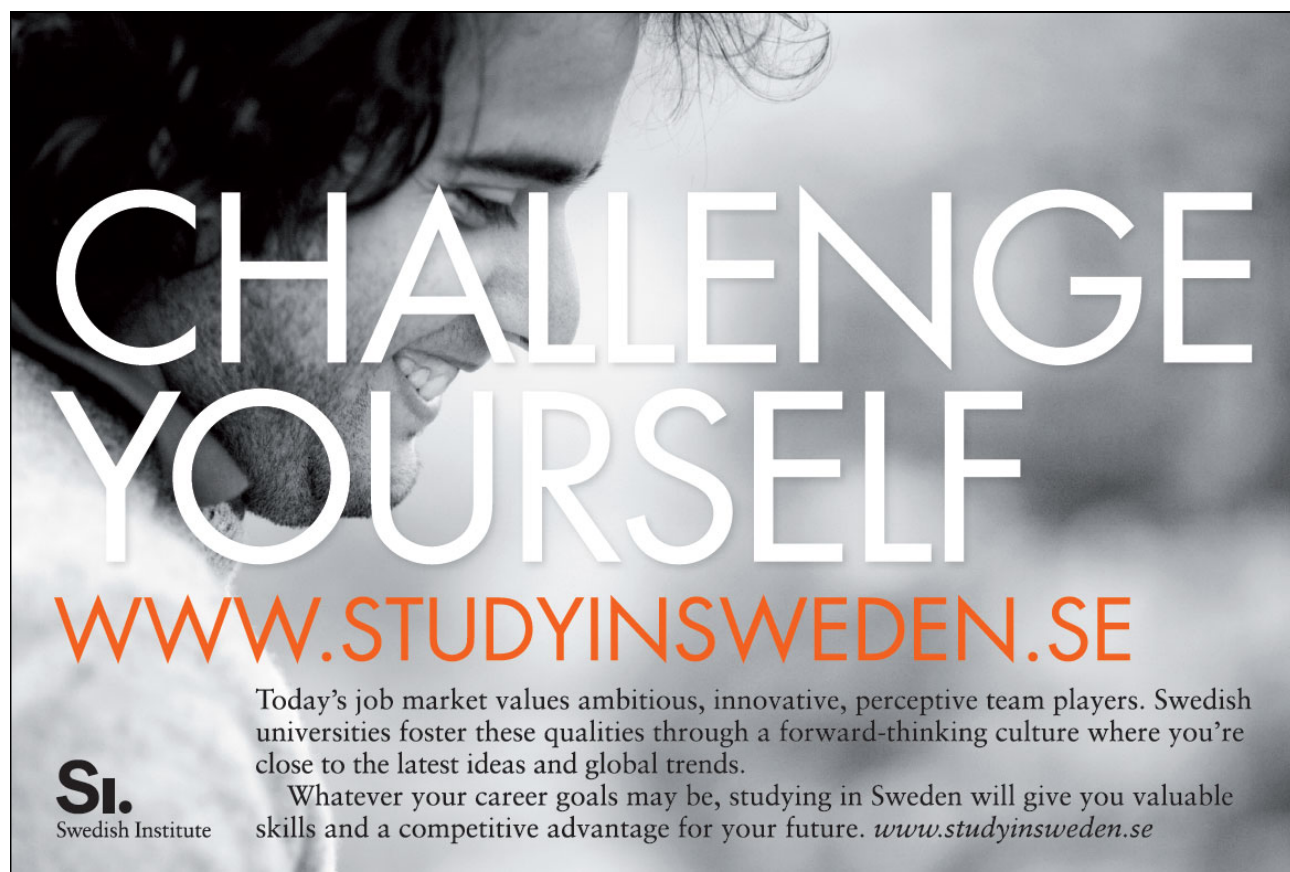

**CHALLENGE
YOURSELF**

WWW.STUDYINSWEDEN.SE

Today's job market values ambitious, innovative, perceptive team players. Swedish universities foster these qualities through a forward-thinking culture where you're close to the latest ideas and global trends.

Whatever your career goals may be, studying in Sweden will give you valuable skills and a competitive advantage for your future. www.studyinsweden.se

Si.
Swedish Institute

Download free books at BookBooN.com

Example 5- F:*pH in a solution of foreign ions*

In an earlier example we have found that the concentration of H_3O^+ ions in a 1.0 M solution of HF is $2.6 \cdot 10^{-2}$ M by which the degree of dissociation is 2.6 %. We wish to determine pH in a solution containing 1.0 M HF as well as 1.0 M NaF. The K_a value for HF is still $7.2 \cdot 10^{-4}$ M. Again it is determined which of the components that are the determining for the pH of the solution. In this case it is:



We wish to determine the position of the following equilibrium:



On the basis on the reaction scheme we have the following equilibrium expression:

$$K_a = 7.2 \cdot 10^{-4} \text{ M} = \frac{[\text{H}_3\text{O}^+] \cdot [\text{F}^-]}{[\text{HF}]}$$

We will now look at the initial and equilibrium conditions analogously to prior examples. The initial concentrations are:

$$\begin{aligned} [\text{HF}]_0 &= 1.0 \text{ M} \\ [\text{F}^-]_0 &= 1.0 \text{ M (from the dissolved NaF)} \\ [\text{H}_3\text{O}^+]_0 &= 10^{-7} \text{ M (from the autoprotolysis of water)} \end{aligned}$$

and the end concentrations are thereby:

$$\begin{aligned} [\text{HF}] &= (1.0 \text{ M} - x) \text{ M} \\ [\text{F}^-] &= (1.0 + x) \text{ M} \\ [\text{H}_3\text{O}^+] &= (10^{-7} + x) \text{ M} \end{aligned}$$

Which gives by insertion into the expression for K_a :

$$K_a = 7.2 \cdot 10^{-4} \text{ M} = \frac{(10^{-7} + x) \cdot (1.0 + x)}{1.0 - x} \Rightarrow x = 7.2 \cdot 10^{-4} \text{ M}$$

Thus the concentrations of H_3O^+ ions are $7.2 \cdot 10^{-4}$ M why pH becomes:

$$\text{pH} = -\log[7.2 \cdot 10^{-4}] = 3.1$$

Again the contribution from autoprotolysis of water is added although in may in practice be neglected.

5.5 Buffer

One of the most important applications of the acid-base chemistry is the buffer capacity. A buffer solution is a solution that counteracts an external action affecting pH. Some of the most well-known buffer solutions are found in the human body where they help to protect the pH of the blood from external actions and to keep the blood at constant pH levels. It is essential for the human body to be able to maintain the pH of the blood at fairly constant levels as certain types of cell only may survive in a close pH window.

A buffer solution may contain a weak acid and its salt or a weak base and its salt. Examples of buffer solutions is e.g. HF / NaF and NH₃ / NH₄Cl. Thereby a buffer solution always consists of a weak acid and its corresponding weak base in amounts close to each other. By choosing the right components and concentrations it is possible to set up buffer capacity at many different pH levels.

5.5.1 The Buffer equation

Knowing an acids strength exponent pK_a it is also possible to calculate pH in a buffer solution and this is the subject for the following section. We take a starting point in the well-known acid-base reaction:

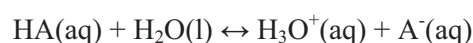

The equilibrium expression for the general acid-base reaction may be expressed as:

$$K_a = \frac{[\text{H}_3\text{O}^+] \cdot [\text{A}^-]}{[\text{HA}]}$$

The equation for K_a is rewritten in order to be able to contain pH. This happens by applying the decimal logarithm on both sides of the equilibrium sign and do a few simple manipulations. Hereby the *buffer equation* arises:

$$\text{pH} = \text{p}K_a - \log \frac{[\text{HA}]}{[\text{A}^-]} \quad (5-3)$$

The buffer equation is also known as the Henderson-Hasselbalch equation. This equation is in principle just another version of the expression for K_a but it may nevertheless other be easier to apply. Using the buffer equation one must remember that HA and A⁻ denotes the corresponding acid-base pair and that pK_a is the acid exponent of the acid (HA). In the following example the buffer effect is illustrated in a buffer system consisting of equal amounts of acetic acid and acetate into which strong base is added.

Example 5- G:*pH in a buffer solution*

A buffer solution consists of 0.5 M acetic acid CH_3COOH (K_a value of $1.8 \cdot 10^{-5}$ M) and 0.5 M sodium acetate CH_3COONa . This solution consists of a weak acid (acetic acid) and its corresponding weak base (acetate ion). As the amount of the weak acid and weak base are similar (it is sufficient if there just in the same order of magnitude) we have a buffer system.

The initial concentrations of acetic acid and the acetate ion are equally large which is why pH in this case is simply equal to the pK_a value of acetic acid according to the buffer equation:

$$pH = pK_a - \log \frac{[\text{CH}_3\text{COOH}]}{[\text{CH}_3\text{COO}^-]} = pK_a - \log(1) = pK_a = 4.74$$

We wish to illustrate the buffer effect by calculating what the pH of the solution becomes when 0,01 moles of solid NaOH is added to 1.0 litre of the buffer solution. As NaOH is a strong base we assume that all NaOH dissociate completely. The determining components in the solution is thereby:



As the solution contains a large amount of the strong base OH^- the following reaction will proceed primarily to the right:

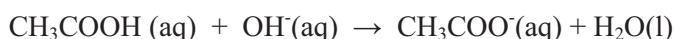

It is advantageous to divide the problem into two parts. First we assume that the reaction above runs dominantly to the right and secondly; we will perform equilibrium calculations.

	$\text{CH}_3\text{COOH}(\text{aq})$	+	$\text{OH}^-(\text{aq})$	\rightarrow	$\text{CH}_3\text{COO}^-(\text{aq})$	+	$\text{H}_2\text{O}(\text{l})$
Prior to reaction:	1,0 L · 0,5 mol/L = 0,5 mol		0,01 mol		1,0 L · 0,5 mol/L = 0,5 mol		
After reaction:	0,5 mol – 0,01 mol		0 mol		0,5 mol + 0,01 mol = 0,51 mol		

Now the problem may be treated as an equilibrium problem. The only difference from the procedure above is that it is only some of the OH^- ions that have reacted with CH_3COOH . We will now look at initial and equilibrium conditions analogously earlier examples. The initial concentrations are:

$$\begin{aligned} [\text{CH}_3\text{COOH}]_0 &= 0.49 \text{ M} \\ [\text{CH}_3\text{COO}^-]_0 &= 0.51 \text{ M} \\ [\text{H}_3\text{O}^+]_0 &\approx 0 \text{ (the autoprotolysis of water is neglected)} \end{aligned}$$

And the final concentrations are thereby:

$$\begin{aligned} [\text{CH}_3\text{COOH}] &= (0.49 - x) \text{ M} \\ [\text{CH}_3\text{COO}^-] &= (0.51 + x) \text{ M} \\ [\text{H}_3\text{O}^+] &= x \text{ M} \end{aligned}$$

Which by insertion into the expression for K_a gives:

$$K_a = 1.8 \cdot 10^{-5} M = \frac{[H_3O^+] \cdot [CH_3COO^-]}{[CH_3COOH]} = \frac{x \cdot (0.51 + x)}{(0.49 - x)} \Rightarrow x = 1.7 \cdot 10^{-5} M$$

The concentration of H_3O^+ ions is thereby $1.7 \cdot 10^{-5} M$ which is why pH becomes:

$$pH = -\log[1.7 \cdot 10^{-5}] = 4.76$$

This pH value could also be found with the use of the buffer equation as we still have a buffer system with a weak corresponding acid-base pair of the same order (x is very small):

$$\begin{aligned} [CH_3COOH] &= (0.49 - x) M \approx 0.49 M \\ [CH_3COO^-] &= (0.51 + x) M \approx 0.51 M \end{aligned}$$

$$pH = pK_a - \log \frac{[CH_3COOH]}{[CH_3COO^-]} = 4.74 - \log \left(\frac{0.49 M}{0.51 M} \right) = 4.76$$

pH has thereby changed from 4.74 to 4.76 (0.02 pH units) by the addition of 0.010 moles solid NaOH to 1 litre of the buffer solution. It shows clearly that the buffer solution is capable of damping the external pH action.

As a comparison we will calculate how much pH would have changed if we had added the same amount of NaOH to 1.0 L of pure water. In this case the concentration of OH^- ions will be 0.01 M. the concentration of H_3O^+ ions may now be calculated knowing the conditions connected with the autoprotolysis of water:

$$K_w = 1.0 \cdot 10^{-14} M^2 = [H_3O^+] \cdot [OH^-] \Rightarrow [H_3O^+] = \frac{1.0 \cdot 10^{-14} M^2}{0.01 M} = 1.0 \cdot 10^{-12} M$$

which is why pH becomes:

$$pH = -\log[1.0 \cdot 10^{-12}] = 12.0$$

which thereby is a change of 5 pH units as pure water has a pH value of 7.0? compared to the buffer solution this is a very large change in pH which clearly shows the pH damping abilities of the buffer solutions.

Similarly the buffer capacity may be illustrated by the addition of an equivalent amount of strong acid to the same type of buffer solution just with a higher concentration of buffer components.

Example 5- H:*Buffer capacity*

We wish to calculate the change in pH when 0.01 moles HCl on gas form is added to 1.0 L of a solution consisting of 5.00 M CH₃COOH and 5.00 M CH₃COONa.

Acetic acid has a pK_a value of 4.74. In this case [CH₃COOH] = [CH₃COO⁻] before HCl is added which is why pH initially may be found via the buffer equation:

$$pH = pK_a - \log \frac{[CH_3COOH]}{[CH_3COO^-]} = 4.74 - \log(1) = 4.74$$

After the addition of HCl the important components in respect to pH are:



Due to the addition of HCl there is quite an amount of H₃O⁺ present in the solution which is why the most important reaction is:

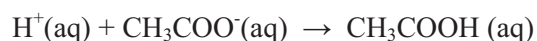

We assume that the reaction runs completely as H₃O⁺ is a strong acid. We will look at the initial and equilibrium conditions analogously prior examples. The initial concentrations are:

$$\begin{aligned} [CH_3COOH]_0 &= 5.00 \text{ M} \\ [CH_3COO^-]_0 &= 5.00 \text{ M} \\ [H_3O^+]_0 &= 0.01 \text{ M (the autoprotolysis of water is neglected)} \end{aligned}$$

and the final concentrations are thereby:

$$\begin{aligned} [CH_3COOH] &= 5.01 \text{ M} \\ [CH_3COO^-] &= 4.99 \text{ M} \\ [H_3O^+] &= 0 \text{ M} \end{aligned}$$

We still have a buffer system as the corresponding weak acid-base pair is present in amounts of the same magnitude. We may therefore calculate pH using the buffer equation:

$$pH = pK_a - \log \frac{[CH_3COOH]}{[CH_3COO^-]} = 4.74 - \log \frac{5.01}{4.99} \approx 4.74$$

This will in other words mean that the pH of the solution more or less has not changed even though HCl has been added. This clearly shows the damping capabilities of the buffer system.

We saw in the previous two examples how buffer systems dampen external pH actions. In example 5-G the initial concentration is 10 times lower than in example 5-H. This means that by addition of equivalent amounts of H^+ and OH^- , the change in pH becomes different. The larger the initial concentration of the buffer components are, the less pH will change by the addition of equivalent amounts of strong acid and strong base respectively. In other words the buffer capacity of the solution increases with the concentration of the buffer components.

5.5.1 Buffer capacity

The buffer capacity is defined on the basis of the amount of OH^- and H_3O^+ ions that the solution may be able to receive without causing a major change in pH. A buffer with a large buffer capacity contains large concentrations of buffer components and may thereby be able to receive large amounts of OH^- and H_3O^+ ions without causing a significant change in pH. In general, pH in a buffer solution is determined by the $[\text{A}^-]/[\text{HA}]$ relation and the buffer capacity are determined by the sizes of $[\text{A}^-]$ and $[\text{HA}]$.

Please click the advert



oxygen.ie

Download 3rd level revision guides for free
– brought to you by oxygen.ie

Download free books at BookBooN.com

5.6 Titrations and pH curves

Titration is often used to analyse the amount of acid and base in a solution. The principle is to continuously add a solution with known concentration to the solution with unknown concentration. The addition is done from a burette in such way that the amount of added volume may be written off afterwards. The point of equivalence is often signalled by a color shift from an indicator added prior to the titration. The process of titration is often depicted by plotting the pH of the unknown solution as a function of the added amount of solution with the known concentration. Calculations of pH for given amounts of solution with the known concentration is done analogously to pH calculations exemplified in earlier sections.

Example 5- 1:*Titration of weak acid with strong base*

We have seen earlier how calculations of pH in solutions with strong acid and strong base are relatively simple because strong acids and strong bases are completely dissociated. On the contrary, pH calculations in cases where the titrated acid is weak is not as simple. In order to be able to calculate the concentration of H_3O^+ ions after the addition of a given amount of strong base it is necessary to look at the weak acids dissociation equilibrium. Calculations of pH curves for titration of a weak acid with a strong base involve a series of buffer-related problems.

We look at the following problem: 50.0 mL 0.10 M CH_3COOH is titrated with 0.100 M NaOH. We wish to determine the pH value in the solution different places in the titration and on the basis of this to be able to draw a titration curve. Acetic acid has a K_a value of $1.8 \cdot 10^{-5}$ M and thereby a pK_a value of 4.74.

Case 1: Not NaOH is added (solution of weak acid)

This problem is one we have met earlier. We are to determine pH in a solution of a weak acid. We are to write the equation of equilibrium with corresponding expression of equilibrium.



$$K_a = 1.8 \cdot 10^{-5} M = \frac{[H_3O^+] \cdot [CH_3COO^-]}{[CH_3COOH]}$$

We now look at the initial and equilibrium concentrations completely analogously earlier examples. The initial concentrations are:

$$\begin{aligned} [CH_3COOH]_0 &= 0.10 \text{ M} \\ [CH_3COO^-]_0 &= 0 \text{ M} \\ [H_3O^+]_0 &\approx 0 \text{ M (the autoprotolysis of water is neglected)} \end{aligned}$$

And the final concentrations are thereby:

$$\begin{aligned} [CH_3COOH] &= (0.10 - x) \text{ M} \\ [CH_3COO^-] &= x \text{ M} \\ [H_3O^+] &= x \text{ M} \end{aligned}$$

which is why we get the following equation:

$$K_a = 1.8 \cdot 10^{-5} M = \frac{[H_3O^+] \cdot [CH_3COO^-]}{[CH_3COOH]} = \frac{x \cdot x}{0.10 - x} \Rightarrow x = 1.3 \cdot 10^{-3} M$$

Thereby $[H_3O^+] = 1.3 \cdot 10^{-3}$ M which is why the pH value in the solution becomes:

$$pH = -\log[H_3O^+] = -\log(1.3 \cdot 10^{-3}) = 2.87$$

Case 2: 10.0 mL 0.10 M NaOH solution has been added – buffer system

Now strong base is added to a weak acid. The following reaction runs completely:

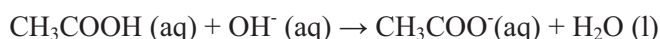

The initial and end-conditions are determined for each of the important components:

$$\begin{aligned} n(CH_3COOH)_0 &= 0.10 \text{ M} \cdot 50 \text{ mL} = 5 \text{ mmol} \\ n(CH_3COO^-)_0 &= 0 \text{ mmol} \\ [OH^-]_0 &= 0.10 \text{ M} \cdot 10 \text{ mL} = 1 \text{ mmol} \text{ (The autoprotolysis of water is neglected)} \end{aligned}$$

The reaction runs completely which is why the end-conditions are:

$$\begin{aligned} n(CH_3COOH)_0 &= 0.10 \text{ M} \cdot 50 \text{ mL} = (5 - 1) \text{ mmol} = 4 \text{ mmol} \\ n(CH_3COO^-)_0 &= 1 \text{ mmol} \\ [OH^-]_0 &\approx 0 \text{ mmol} \text{ (The autoprotolysis of water is neglected)} \end{aligned}$$

We now have a corresponding weak acid base pair in the same order. The pH value may be determined using the buffer equation:

$$pH = pK_a - \log \frac{[CH_3COOH]}{[CH_3COO^-]} = pK_a - \log \frac{n(CH_3COOH)}{n(CH_3COO^-)} = 4.74 - \log \frac{4}{1} = 4.14$$

Case 3: 25.0 mL 0.10 M NaOH solution has been added – buffer system

The procedure is completely analogous case number 2. The following reaction running completely to the right is once again written as follows:

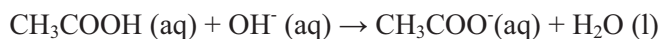

The initial and end-conditions are written for the different components:

$$\begin{aligned} n(CH_3COOH)_0 &= 0.10 \text{ M} \cdot 50 \text{ mL} = 5 \text{ mmol} \\ n(CH_3COO^-)_0 &= 0 \text{ mmol} \\ [OH^-]_0 &= 0.10 \text{ M} \cdot 25 \text{ mL} = 2.5 \text{ mmol} \text{ (the autoprotolysis of water is neglected)} \end{aligned}$$

The reaction runs completely which is why the end conditions becomes:

$$n(CH_3COOH)_0 = 0.10 \text{ M} \cdot 50 \text{ mL} = (5 - 2.5) \text{ mmol} = 2.5 \text{ mmol}$$

$$n(\text{CH}_3\text{COO}^-)_0 = 2.5 \text{ mmol}$$

$$[\text{OH}^-]_0 \approx 0 \text{ mmol (the autoprotolysis of water is neglected)}$$

We still have a corresponding weak acid base pair in the same amount and the pH value may be calculated in terms of the buffer equation:

$$pH = pK_a - \log \frac{[\text{CH}_3\text{COOH}]}{[\text{CH}_3\text{COO}^-]} = pK_a - \log \frac{n(\text{CH}_3\text{COOH})}{n(\text{CH}_3\text{COO}^-)} = 4.74 - \log(1) = 4.74$$

The point at the titration curve after the addition of 25.0 mL NaOH solution is special as it is half way to the equivalence point. The original solution contained 50.0 mL of a 0.10 M CH₃COOH solution corresponding to $5.0 \cdot 10^{-5}$ mol CH₃COOH. It thereby takes $5.0 \cdot 10^{-5}$ moles of OH⁻ ions before the equivalence point is reached. This requires in our case 50.0 mL of a 0.10 M NaOH solution. After having added 25.0 mL NaOH we are half way towards the equivalence point. Thereby the pH value half way towards the equivalence point always equal to the pK_a value for the acid of the buffer system.

Case 4: 50.0 mL 0.10 M NaOH solution has been added – solution of a weak base

After the addition of a 50.0 mL NaOH solution we are now at the point of equivalence which means that there are equal amounts of acetic acid and OH⁻ ions. The primary contribution to pH in the solution is thereby the weak base CH₃COO⁻ because the following reaction runs completely:

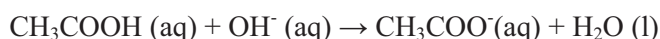

All acetic acid is now brought to acetate form (CH₃COO⁻). The problem is now to determine pH in a solution of a weak base with a concentration of 0.05 M (half of the initial concentration). The base equilibrium and the corresponding base equilibrium constant K_b ($5.6 \cdot 10^{-10}$ M) are to be written:

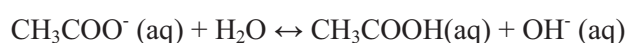

$$K_b = 5.6 \cdot 10^{-10} \text{ M} = \frac{[\text{OH}^-] \cdot [\text{CH}_3\text{COOH}]}{[\text{CH}_3\text{COO}^-]}$$

Once again we look at the initial and end conditions:

$$[\text{CH}_3\text{COO}^-]_0 = 5.0 \cdot 10^{-3} \text{ mol} / (0.0500 \text{ L} + 0.0500 \text{ L}) = 5.0 \cdot 10^{-2} \text{ M}$$

$$[\text{OH}^-]_0 \approx 0 \text{ M (the autoprotolysis of water is neglected)}$$

$$[\text{CH}_3\text{COOH}]_0 = 0 \text{ M}$$

and the end conditions are thereby:

$$[\text{CH}_3\text{COOH}] = (5.0 \cdot 10^{-2} - x) \text{ M}$$

$$[\text{OH}^-] \approx x \text{ M}$$

$$[\text{CH}_3\text{COO}^-] = x \text{ M}$$

Hereby the following equation is:

$$K_b = 5.6 \cdot 10^{-10} \text{ M} = \frac{x \cdot x}{0.050 - x} \Rightarrow x = 5.3 \cdot 10^{-6} \text{ M}$$

Thus, the concentrations of OH^- ions is $5.3 \cdot 10^{-6} \text{ M}$, which is why the concentration of H_3O^+ ions are found using knowledge of the autoprotolysis of water:

$$[\text{H}_3\text{O}^+] \cdot [\text{OH}^-] = K_w \Rightarrow [\text{H}_3\text{O}^+] = \frac{1.0 \cdot 10^{-14} \text{ M}^2}{5.3 \cdot 10^{-6} \text{ M}} = 1.9 \cdot 10^{-9} \text{ M}$$

pH is calculated:

$$\text{pH} = -\log[1.9 \cdot 10^{-9}] = 8.72$$

It is seen that the point of equivalence is somewhat in the basic areas. This is always the case for titrations of a weak acid with a strong base.

Case 5: 60.0 mL 0.10 M NaOH solution has been added – solution of a strong base

When further OH^- ions are added after the point of equivalence these ions will dominate in respect to the weak base (CH_3COO^- ions). Thus, pH may be determined from the excess concentrations of OH^- ions. The concentration of excess OH^- ions may be determined as:

$$[\text{OH}^-] = \frac{\text{mol } \text{OH}^- \text{ ioner i overskud}}{\text{total volumen}} = \frac{1.0 \cdot 10^{-3} \text{ mol}}{(0.0500\text{L} + 0.0600\text{L})} = 9.1 \cdot 10^{-3} \text{ M}$$

Thus, the concentrations of OH^- ions is $9.1 \cdot 10^{-3} \text{ M}$ which is why the concentration of H_3O^+ ions again may be found as:

$$[\text{H}_3\text{O}^+] \cdot [\text{OH}^-] = K_w \Rightarrow [\text{H}_3\text{O}^+] = \frac{1.0 \cdot 10^{-14} \text{ M}^2}{9.1 \cdot 10^{-3} \text{ M}} = 1.1 \cdot 10^{-12} \text{ M}$$

Which is why pH becomes:

$$\text{pH} = -\log[1.1 \cdot 10^{-12}] = 11.96$$

On the basis of such calculations as in the five cases it is possible to make a titration curve. This curve may be seen from figure 5-2.

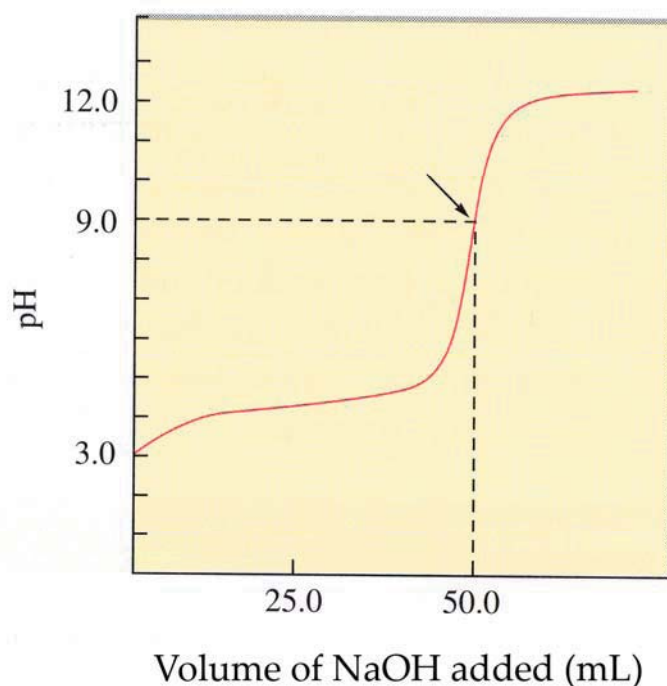

Figure 5- 2: Titration curve

The titration of 50.0 mL CH_3COOH with a 0.10 M NaOH solution. Note how the point of equivalence marked by the red arrow is in the basic region due to the presence of CH_3COO^- ions.

Please click the advert



DIVERSE - INNOVATIVE - INTERNATIONAL

Are you considering a European business degree?

Copenhagen Business School is one of the largest business schools in Northern Europe with more than 15,000 students from Europe, North America, Australia and Asia.

Are you curious to know how a modern European business school competes with a diverse, innovative and international study environment?

Please visit Copenhagen Business School at www.cbs.dk



Diversity creating knowledge



The shape of the titration curve depends on the strength of the acid in solution. After the point of equivalence the shape is nevertheless identical but before the shape is characteristic for the acid strength. The climb of the titration curve is more steep for the weak acid than for the strong acid. The levelling-off of the curve for the weak acid is caused by the buffer effect as earlier emphasised. A buffer system functions optimal when $[HA] = [A^-]$ which is exactly half way to the equivalence point. This is way the weak acid titration curve here is more flat than it is the case for the strong acid at the same location.

Of other differences between the titration curves for the weak and the strong acid may be pointed out that the pH value for the equivalence point is different. For the titration of the strong acid the point is at a pH value of 7.0 whereas the point of equivalence is in the basic region due to the corresponding weak base strength. It is important to note the point of equivalence is defined on the basis of stoichiometry and not from pH. The general shapes of titration curves for the titration of strong and weak acids may be seen from figure 5-3 A) and B).

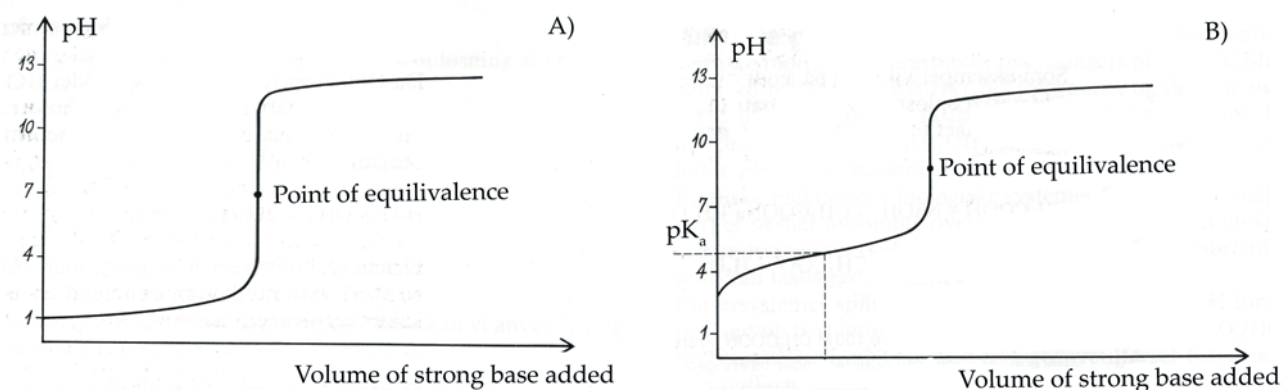

Figure 5- 3: Different titration curves

General shapes of titration curves for the titration of a strong acid with a strong base A) and the titration of a weak acid with a strong base B).

5.6.1 Titration of polyprotic acids

So far we have only looked at titration of acids capable of removing one H^+ ion. The titration of polyprotic acids requires in principles calculations of pH similar to our prior examples although one must keep track of more things. This we will further look into in the following example.

Example 5- J:*Titration of a divalent acid*

We look at the general divalent acid H_2A which we assume have the following two K_a value:

$$K_{a1} = 1.0 \cdot 10^{-4} \text{ M and } K_{a2} = 1.0 \cdot 10^{-9} \text{ M} \Rightarrow \\ pK_{a1} = 4.0 \text{ and } pK_{a2} = 9.0$$

We are to titrate 20.0 mL 0.100 M solution of H_2A with a 0.100 M solution of the strong base NaOH and we wish to determine pH during titration.

At the start of titration we have a 0,100 M solution of the acid H_2A which is a weak acid what may be seen from the first K_a value.

Analogously earlier calculations we have the following equilibrium with corresponding expression of equilibrium:

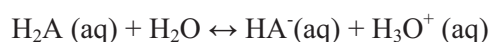

$$K_{a1} = 1.0 \cdot 10^{-4} \text{ M} = \frac{[H_3O^{\oplus}] \cdot [HA^{\ominus}]}{[H_2A]}$$

As earlier we now look at start and equilibrium conditions. The initial concentrations are:

$$[H_2A]_0 = 0.100 \text{ M} \\ [HA^{\ominus}]_0 = 0 \text{ M} \\ [H_3O^{\oplus}]_0 \approx 0 \text{ M (the autoprotolysis of water is neglected)}$$

and the end concentrations are thereby:

$$[H_2A] = (0.100 - x) \text{ M} \\ [HA^{\ominus}] = x \text{ M} \\ [H_3O^{\oplus}] \approx x \text{ M}$$

which is why we get the following equation:

$$K_{a1} = 1.0 \cdot 10^{-4} \text{ M} = \frac{[H_3O^{\oplus}] \cdot [HA^{\ominus}]}{[H_2A]} = \frac{x \cdot x}{0.100 - x} \Rightarrow x = 3.1 \cdot 10^{-3} \text{ M}$$

Thereby $[H_3O^{\oplus}] = 3.1 \cdot 10^{-3} \text{ M}$ and the pH value becomes:

$$pH = -\log[H_3O^+] = -\log(3.1 \cdot 10^{-3}) = 2.51$$

On the way to the first point of equivalence we have a buffer system consisting of the weak acid H_2A and the corresponding weak base HA^- which is why pH does not change very much. Halfway towards the first point of equivalence pH I calculated from the buffer equation:

$$pH = pK_{a1} - \log\left(\frac{H_2A}{HA^-}\right) = pK_{a1} = 4.00$$

We note that half way towards the point of equivalence the amounts of H_2A and HA^- are equally large why the logarithmic relation becomes 0. First point of equivalence is reached when the amount of H_2A is equal to the amount of added NaOH exactly when 20.0 mL of 0,100 M NaOH is added. We there have a solution containing HA^- which may function both as an acid and as a base. Such a specie is called an amfolyte and pH in such solutions may be determined from the following equation:

$$pH = \frac{1}{2} \cdot (pK_a(\text{acid}) + pK_a(\text{amfolyte})) \quad (5-4)$$

As both K_a values are known pH is:

$$pH = \frac{1}{2}(4.0 + 9.0) = 6.50$$

Between the first and the second point of equivalence we have a buffer system in this case consisting of a weak acid HA^- and its corresponding weak base A^{2-} . Halfway towards the second point of equivalence we have from the buffer equation:

$$pH = pK_{a2} - \log\left(\frac{HA^-}{A^{2-}}\right) = pK_{a2} = 9.00$$

The second and last point of equivalence is reached when the amount of NaOH is the double of the initial amount of H_2A which is when 40.0 mL of 0,100 M NaOH is added. All the acid is now on the base form A^{2-} and the volume of the solution is increased to totally 60.0 mL. Now the problem is to determine pH in a solution of the base A^{2-} if the "initial" concentration is:

$$[A^{2-}] = \frac{0.0200L \cdot 0.100 \text{ mol} / L}{0.0600L} = 3.3 \cdot 10^{-2} \text{ mol} / L$$

Now we write in normal fashion the aqueous equilibrium with corresponding equilibrium expression.

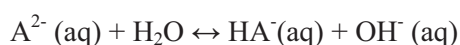

$$K_b(A^{2-}) = \frac{K_w}{K_a(HA^-)} = \frac{1.0 \cdot 10^{-14} M^2}{1.0 \cdot 10^{-9} M} = 1.0 \cdot 10^{-5} M = \frac{[OH^-] \cdot [HA^-]}{[A^{2-}]}$$

Once again we look at the initial and end concentrations:

$$\begin{aligned} [A^{2-}]_0 &= 3.3 \cdot 10^{-2} M \\ [HA^-]_0 &= 0 M \\ [OH^-]_0 &\approx 0 M \text{ (the autoprotolysis of water is neglected)} \end{aligned}$$

And the end concentrations are thereby:

$$\begin{aligned} [A^{2-}] &= (3.3 \cdot 10^{-2} - x) M \\ [HA^-] &= x M \\ [OH^-] &\approx x M \end{aligned}$$

Hereby we arrive at the following equation:

$$K_b = 1.0 \cdot 10^{-5} M = \frac{x \cdot x}{3.3 \cdot 10^{-2} - x} \Rightarrow x = 5.7 \cdot 10^{-4} M$$

The concentration of OH^- ions is $5.7 \cdot 10^{-4} M$ which is why the concentration of H_3O^+ ions is found as:

$$[H_3O^+] \cdot [OH^-] = K_w \Rightarrow [H_3O^+] = \frac{1.0 \cdot 10^{-14} M^2}{5.7 \cdot 10^{-4} M} = 1.7 \cdot 10^{-11} M$$

why pH becomes:

$$pH = -\log[1.7 \cdot 10^{-11}] = 10.8$$

After the second point of equivalence the solution only contains a solution of the weak base A^{2-} as well as the strong base OH^- ions from the added NaOH in excess. In such a case we will as earlier neglect the contribution from A^{2-} to pH and thereafter calculate pH as if there were only the strong base OH^- present in the solution.

5.6.2 Colour indicators for acid/base titration

Apart from using a pH meter to determine the pH value in a given solution a colour indicator is often added to a given solution that is to be titrated. Such a colour indicator changes colour when the point of equivalence is reached. A typical colour indicator is a complex molecule, often being actually a weak acid itself. In

general an indicator may be represented as "HIn". Colour indicators exhibit one colour with the proton and another colour without the proton. A well-known example is phenolphthalein which is opaque in its HIn form while the colour changes to violet in its In⁻ form. We will briefly look into how such a molecule may function as indicator in order to achieve knowledge of what is going on during titration.

We look at a representative hypothetical color indicator HIn which is a weak acid with a K_a value of $1.0 \cdot 10^{-8}$ M. HIn is in equilibrium with:



The indicator is red in its HIn form while the colour is blue when on the In⁻ form. Correspondingly, the equilibrium reaction the following equilibrium fraction is achieved:

$$K_a = \frac{[\text{H}^+] \cdot [\text{In}^-]}{[\text{HIn}]} \Leftrightarrow \frac{K_a}{[\text{H}^+]} = \frac{[\text{In}^-]}{[\text{HIn}]}$$

Assume that a few drops of indicator is added to a solution where pH = 2.0. From above we get that the relation between In⁻ and HIn is:

$$\frac{K_a}{[\text{H}^+]} = \frac{1.0 \cdot 10^{-8} \text{ M}}{(10^{-\text{pH}}) \text{ M}} = \frac{1}{1000000}$$

Please click the advert



Sharp Minds - Bright Ideas!

Employees at FOSS Analytical A/S are living proof of the company value - First - using new inventions to make dedicated solutions for our customers. With sharp minds and cross functional teamwork, we constantly strive to develop new unique products - Would you like to join our team?

FOSS works diligently with innovation and development as basis for its growth. It is reflected in the fact that more than 200 of the 1200 employees in FOSS work with Research & Development in Scandinavia and USA. Engineers at FOSS work in production, development and marketing, within a wide range of different fields, i.e. Chemistry, Electronics, Mechanics, Software, Optics, Microbiology, Chemometrics.

We offer
A challenging job in an international and innovative company that is leading in its field. You will get the opportunity to work with the most advanced technology together with highly skilled colleagues.

Read more about FOSS at www.foss.dk - or go directly to our student site www.foss.dk/sharpminds where you can learn more about your possibilities of working together with us on projects, your thesis etc.

The Family owned FOSS group is the world leader as supplier of dedicated, high-tech analytical solutions which measure and control the quality and production of agricultural, food, pharmaceutical and chemical products. Main activities are initiated from Denmark, Sweden and USA with headquarters domiciled in Hillerød, DK. The products are marketed globally by 23 sales companies and an extensive net of distributors. In line with the corevalue to be 'First', the company intends to expand its market position.





Dedicated Analytical Solutions

FOSS
 Slangerupgade 69
 3400 Hillerød
 Tel. +45 70103370
www.foss.dk

This simple calculation indicates clearly that the dominating form is HIn which is why the solution we appear as red.

A relevant question is thereby how much of In^- that have to be in the solution in respect to HIn in order for the human eye to be able to detect the two colours. For the most indicators it is a rule of thumb that at least one tenth of HIn must be changed into In^- before the human eye may be able to detect the change in colour.

5.7 Summing up on chapter 5

In this fifth chapter we have looked at central part of the aqueous chemistry being acid/base chemistry. We initially saw how a H^+ ion from the acid to the base is transferred and how acid strength is defined analogously to the principles of equilibrium we say earlier in chapter 4. further the pH scale was defined and we saw how water molecules may be able to react with itself in the process of autoprotolysis. The autoprotolysis of water contributes to the H_3O^+ and OH^- concentration but may in most cases be neglected unless the calculated values of H_3O^+ and OH^- concentrations are in the order of 10^{-6} M or less.

Calculations of pH in different types of solutions was exemplified including calculations of pH values I strong and weak acid solutions. As an example of an advanced pH calculation we saw how pH values may be calculated in a solution containing two weak acids. It was clear from these examples how closely pH calculations are connected to the equilibrium conditions in the given solution.

We saw in the following section how polyprotic acids are capable of providing more H^+ ions in several steps and we saw how pH ay be calculated in solutions of polyprotic acids. In connection with this we looked briefly at acid and base properties of salt and on how pH may be calculated in such salt solutions. In connection with the influence of foreign ions on the equilibrium conditions in chapter 4 we looked briefly at ion effects and its influence on pH conditions.

Further we introduced buffer chemistry and saw how pH may be calculated in buffer solutions and on how the buffer equation is often used in practice. When one has a solution of a weak acid and its corresponding weak base, both in concentrations of the same magnitude, one has a buffer system and the buffer equation may be used to calculate pH. Lastly, we looked at titration and on pH curves exemplified through examples of titration of monovalent weak acid with strong base and titration of divalent acid likewise with strong base NaOH. In the end we saw how colour indicator work.

6. Electrochemistry

In a number of the chemical processes we are using in our daily life we are using electrochemistry. As the name implies electrochemistry has to do with the transfer of electrons. In general electrochemistry is that part of chemistry that involves the transfer between chemical and electrical energy including the generation of electrical current from chemical processes. Hereby the principles concerning oxidation and reduction are central part which will be introduced first in the following chapter.

6.1 Oxidation and reduction

We have in earlier chapters seen how some chemical compounds are ionic. E.g. are the well-known sodium chloride NaCl in solid form formed from the reaction between solid sodium metal and chlorine gas I the following reaction:

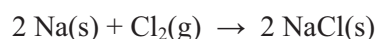

In this reaction a reaction takes place between the Na(s) and the diatomic Cl₂ molecules whereby the ionic NaCl is formed consisting of Na⁺ ions and Cl⁻ ions in a lattice. In a reaction there is a transfer of electrons and such reactions are known as oxidation/reduction reactions or simply in short *redox-reactions*.

Please click the advert

**Design your
own future at
MAN Diesel**

www.mandiesel.com

MAN Diesel – Powering the World



Download free books at BookBooN.com

Many important chemical reactions involve oxidation and reduction. E.g. are the chemical reactions involved in the production of energy typical redox-reactions. This also includes the conversion of food into energy in the human body. Oxidation is defined as an increase of the oxidation level while reduction on the contrary is defined as a decrease in the oxidation level explained in the following section.

6.1.1 Level of oxidation

In order to keep track of the number of electrons in a redox-reaction the so-called levels of oxidation are introduced. They are defined from a certain set of rules defining how the electrons should be divided between the components in the covalent bindings. We will look further into these rules below but first it is necessary to recall the phenomenon of electro negativity. We saw earlier how different atoms have different electro negativity meaning that the different atoms have different ability to attract electrons from other atoms. This has also importance in respect to chemical bindings. As earlier presented the non-metals in the upper corner of the periodic system have the best abilities to attract electrons. Examples of this are fluorine, oxygen, nitrogen and chlorine. The orders for these atoms are according to electro negativity as follows:



Fluorine has thereby the largest ability to attract electrons followed by oxygen, nitrogen and chlorine. Such considerations have importance in respect to the rules for oxidation levels summarised here:

- The oxidation level of a neutral atom/molecule is zero. E.g. is the oxidation level of $H_2(g)$ and $Na(s)$ both zero.
- The oxidation level of a mono atomic ion is the same as the charge. Thereby the oxidation level of the Na^+ ion +1 while it is -1 for the Cl^- ion.
- In covalent compounds with non-metals the hydrogen is given an oxidation level of +1. This means that in the following compounds the oxidation level for hydrogen all are +1 per hydrogen atom: HCl , NH_3 and H_2O . Thereby the oxidation level is -1 for Cl in HCl , -3 for N in NH_3 and -2 for O in H_2O .
- Oxygen is given the oxidation level -2 in covalent compounds as e.g. in CO , CO_2 and SO_3 . the only exception from this rule is in peroxide compounds (containing the O_2^{2-} group) as e.g. H_2O_2 where each of the oxygen atoms is given the level of -1.
- In binary compounds the atom with the largest electro negativity is given the oxidation level of its negative charge. E.g. is flour always given the oxidation level of -1 while nitrogen typically is given the level of -3 and sulphur typically -2.
- The sum of the oxidation levels must be zero for an un-charged compound. E.g. must the sum of oxidation levels for hydrogen and oxygen be zero in H_2O while the sum of oxidation level must be +1 in compounds as NH_4^+ and similarly -2 in compounds as CO_3^{2-} .

Example 6- A:*Assigning levels of oxidation*

We are to assign levels of oxidation to all atoms in the following compounds:



Levels of oxidations in CO_2 :

From the rules on the above we have that each oxygen atom is assigned the oxidation level of -2. the oxidation step for C may thereby be determined on the basis of this and the fact that CO_2 does not have any external charge which is why the sum of oxidation levels should be zero. Thus, C in CO_2 has a level of oxidation of +4.

Levels of oxidations in H_2SO_4 :

Based on the rules earlier stated we have shown that the oxygen atom is given a level of -2 while the hydrogen atom is given a level of +1. The oxidation level for S may thereby be determined on the basis of this as well as on the basis of the fact that H_2SO_4 does not have an external charge meaning that the sum of the oxidation levels must be zero. Hence, S in H_2SO_4 has the oxidation level of +6

Levels of oxidations in NO_3^- :

From the rules earlier stated we have that each oxygen atom is assigned the level of oxidation of -2. the level of oxidation for N may thereby be determined on the basis of this as well as on the fact that NO_3^- have an external charge of -1 which is why the sum of the oxidation levels must be -1 according to the rules. Thus, N in NO_3^- has a level of oxidation of +5.

Levels of oxidations in HF:

According to the rules above we have that each hydrogen atom is assigned the level of oxidation of +1. the level of oxidation for F may be determined on the basis of this as well as the fact that HF does not have an external charge. Hence, F in HF has the level of oxidation of -1 which also fits with the rule that the most electronegative component in a compound are assigned the negative level of oxidation as well as that case that fluorine always are assigned a -1 level in chemical compounds.

6.1.2 Methods for balancing redox reactions

One thing is to determine levels of oxidation for single compounds but to be able to use the levels of oxidation in practice it is necessary to balance a redox-equation. The Redox reactions are often complicated and it is thereby necessary to achieve a certain routine in matching such redox equations. We first look briefly at the following redox-reaction which has to be balanced:

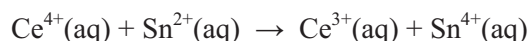

This reaction may be divided into the following half-reactions where the first gives the reduction and the last half-reaction gives the oxidation:

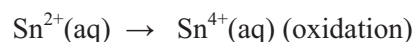
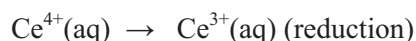

The principle in the work of progress is to balance the two half-reactions separately and add them together in order to achieve the balanced overall reaction. This we will look into in the following example:

Please click the advert

The advertisement features a light blue background with a white border. It displays a sequence of four icons in a row, separated by plus signs and an equals sign. The first icon is a black square with a white shopping cart icon, labeled 'Student Discounts'. The second is a blue square with a white calendar icon showing '2009', labeled 'Student Events'. The third is a grey square with a white pound symbol (£), labeled 'Money Saving Advice'. The fourth is a yellow square with a white star icon, labeled 'Happy Days!'. Below the icons, the text 'wealthystudent.co.uk' is written in a bold, sans-serif font, with 'wealthy' in dark grey and 'student.co.uk' in light blue.

Download free books at BookBooN.com

Example 6- B:*The method of half-reaction in acid aqueous solution*

We consider the following redox-reaction that we wish to balance in an acid solution:

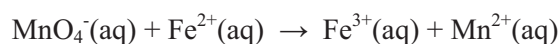

This reaction is often used to analyse the contents of iron in iron ore. The first step is to identify and write the reaction equations for the half-reaction. First we write the half-reactions for the oxidation reaction. It is clear from the overall reaction that it is the iron ion that is oxidised which is why the oxidation equation becomes:

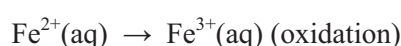

Similarly the reductions half reaction is associated with the manganese-ion and is written as follows:

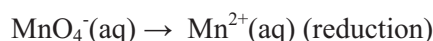

The next step is to balance each of the half-reactions in order to match the charge on each side. The equations are balanced in terms of electrons:

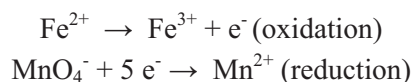

Now the charges match on each side of the half-reactions. In order to make the equations ready for addition the oxidation reaction should be multiplied with "5" as the reduction reaction involves 5 electrons while the oxidation only involves 1 electron. We thereby gets:

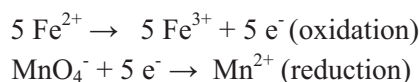

Now the equations are added:

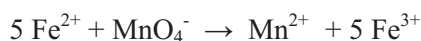

The next step is to balance the reaction in order to match the charges on an overall basis. When we have an acid solution we balance with H^+ -ions while we balance with OH^- in basic solutions. The charges on both sides of the reaction arrow are calculated as follows:

$$\begin{aligned} 5 \times (+2) + (-1) &\rightarrow (+2) + 5 \times (+3) = \\ +9 &\rightarrow +17 \end{aligned}$$

We thereby have to place 8 H^+ -ions on the left side in order to make sure that there is the same number of charges of on the left and the right side:



The last step is to balance with H_2O in order to make sure that there is the same number of atoms of both side of the reaction arrow. In this case it is sufficient to place 4 H_2O -molekules on the right side:

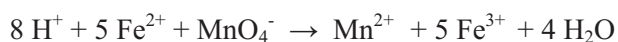

As an extra control one may check if the charges are the same of both sides of the reaction arrow:

Left side: $8 \cdot (+1) + 5 \cdot (+2) + (-1) = +17$

Right side: $(+2) + 5 \cdot (+3) + 4 \cdot 0 = +17$

As an extra-extra control one may make sure that there are equally many of each type of atoms on both sides of the reaction arrow:

Left side: 5 Fe, 1 Mn, 4 O, 8 H

Right side: 5 Fe, 1 Mn, 4 O, 8 H

Even though there is only a minor difference between the balance of redox reactions in acid and basic solutions the principles differ in that the equation are balanced with OH^- ions in stead of H^+ . this we will look into in the following example:

Please click the advert

Read The Spanner online on oxygen.ie

Download free books at BookBooN.com

Example 6- C:

The method of half-reaction in basic aqueous solution

Silver is sometimes found as large lumps mixed with other metals in ore form. An easy method to extract the silver is with the use of the cyanide ion CN^- through the following reaction in basic solution:

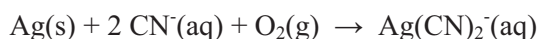

We will balance the reaction equation using the half-reaction principle. The first step is to identify and write the reaction equations for the half-reactions. First we write the half-reactions for the oxidation reaction:



Similarly for the reduction reaction as follows as we do not know the product from this reaction:

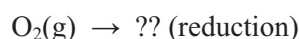

The next step is to balance each of the half-reactions in order to make sure that the charges fit. The balancing is once again done with electrons. For the oxidation reaction we have:



We do not know the product of the reaction but from the general rules stated earlier we know that oxygen is often in the level of oxidation of -2. We thereby assume the product of the reduction reaction is O^{2-} . The balancing with electron thereby becomes:

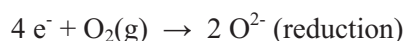

As the oxidation involves 1 electron and the reduction involves 4 electrons we multiply the oxidation with 4 and hereby the half-reactions are added giving:

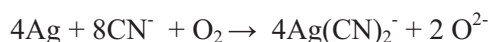

In basic solution we have oxide but not on the O^{2-} form but rather on the protonised OH^- form giving:

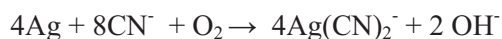

The charges of both sides are calculated and balanced:

$$\begin{aligned} 4 \times (0) + 8 \times (-1) + (0) &\rightarrow 4 \times (-1) + 2 \times (-1) = \\ &-8 \rightarrow -6 \end{aligned}$$

As we have a basic solution we balance with 2 OH⁻ on the right side of the reaction giving:

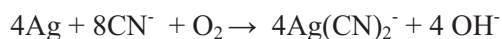

Last step is to balance with water molecules such that the atoms match on both sides of the reaction arrow. In the last case we balance with 2 H₂O-molecules on the left side:

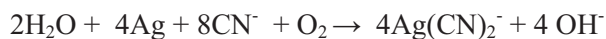

As an extra control one may control that the charges match on both sides of the reaction arrow:

Left side: $8 \cdot (-1) = -8$

Right side: $4 \cdot (-1) + 4 \cdot (-1) = -8$

As an extra-extra control one may make sure that there are equally many of each type of atoms on both sides of the reaction arrow:

Left side: 4 Ag, 8 C, 4 O, 8 N, 4 H

Right side: 4 Ag, 8 C, 4 O, 8 N, 4 H

WHAT'S MISSING IN THIS EQUATION?

You could be one of our future talents

MAERSK INTERNATIONAL TECHNOLOGY & SCIENCE PROGRAMME

Are you about to graduate as an **engineer** or **geoscientist**? Or have you already graduated? If so, there may be an exciting future for you with A.P. Moller - Maersk.



MAERSK

www.maersk.com/mitas

Please click the advert

6.2 Galvanic cells

We saw in the previous section how redox reactions involves the transfer of electrons and how the oxidation means loss of electrons (increase in level of oxidation) while the reduction means increase in electrons (decrease in level of oxidation). In order to understand how a redox reaction may generate current we first look at the following reaction between MnO_4^- and Fe^{2+} that was balanced in example 6-B.

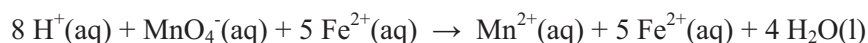

In this reaction Fe^{2+} is oxidised while MnO_4^- is reduced. Electrons are thereby being transferred from Fe^{2+} to MnO_4^- . We will look further into each of the half-reactions separately. We have the reduction reaction:

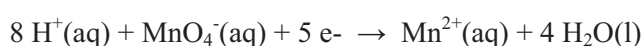

and similarly the oxidation reaction:

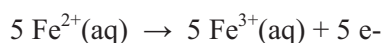

Note how the oxidation reaction must take place five times each time the reduction reaction takes place. When MnO_4^- and Fe^{2+} are present in the same solution the electrons are transferred directly when the reactants collide. Under these conditions no energy may be extracted as all the chemical energy is lost as heat. How may we then extract energy from the reaction above? The answer is to separate the oxidation reaction from the reduction reaction which requires a wire (e.g. of copper). The current that runs between the two solutions may be let through e.g. an electrical bulb or through an electrical motor. Thereby we have extracted energy from a chemical reaction. This principle requires that a salt bridge is established in addition to the wire in order to allow transport of ions without completely mixing the solutions significantly. This principle is sketched in figure 6-1.

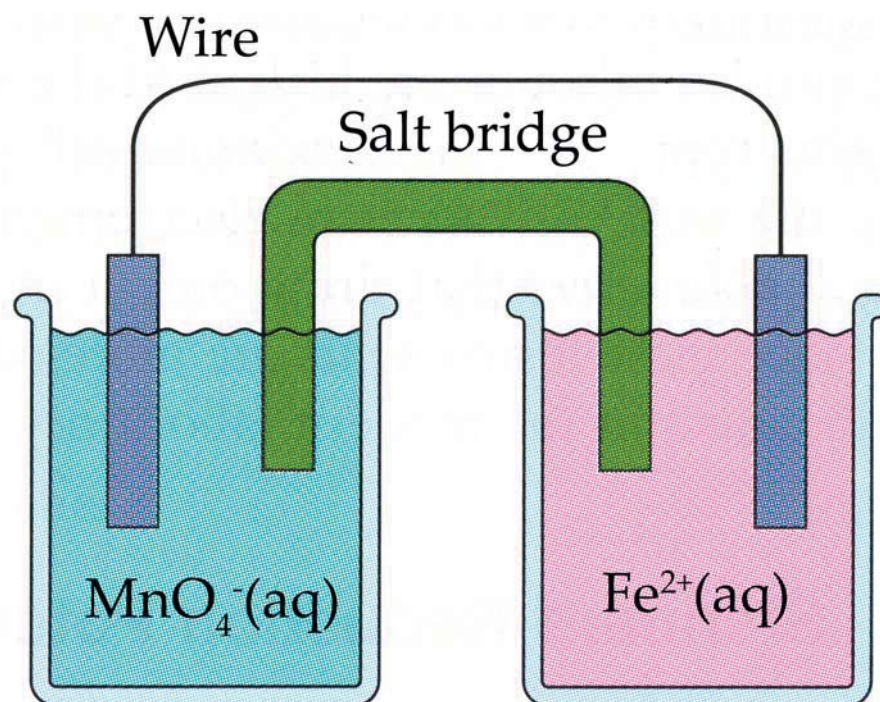

Figure 6- 1: The principle of a galvanic cell

Schematic set-up of the separation of oxidation- and reduction-reaction in a redox-reaction between Fe^{2+} and MnO_4^-

We have described the principal parts in a galvanic element (also known as the galvanic cell) which is a set-up where chemical energy is transferred into electrical energy. The reaction in an electrochemical cell takes place in the boundary between the electrode (the part that is dipped into the solution) and the solution itself. The electrode where the oxidation reaction takes place is called the anode while the electrode where the reduction takes place is called the cathode.

6.2.2 Cell potentials

A galvanic cell consists, as we have seen, in principle of an oxidation component in a container that draws electrons through a wire from a reduction component in another solution. The driving force causing the transfer is called the cell potential or sometimes the electromotoric force (in short EMK). The unit for cell potentials is volt (in short: V) defined as joules of work coulomb charge transferred. The electromotoric force is defined as:

$$EMK = \text{cell potential} = \frac{\text{work (J)}}{\text{charge (C)}} \quad (6-1)$$

In order for a cell reaction to take place spontaneously it is necessary that the cell potential is positive.

6.3 Standard reduction potentials

The reaction in a galvanic cell is always a redox reaction that may be divided into two half-cell reactions in a similar fashion as we have seen it earlier. As well as there is a cell potential for the whole cell there is also a half-cell potential associated with the half-cell reaction. The cell potential for the entire cell is thereby the sum of the two half-cell reactions. This we will look further into in the following example.



Example 6- D:*Half-cell potentials*

A galvanic cell contains a solution of ZnSO_4 connected through a porous wall (similar to the salt bridge presented earlier) with a solution of HCl . In the zinc sulphate solution is placed a rod of zinc metal connected to a platinum electrode placed in the hydrochloric acid solution. Simultaneously H_2 in gas form is lead through the platinum electrode. Between the platinum and zinc electrode is placed a voltmeter. The figure below presents the set-up of a galvanic cell.

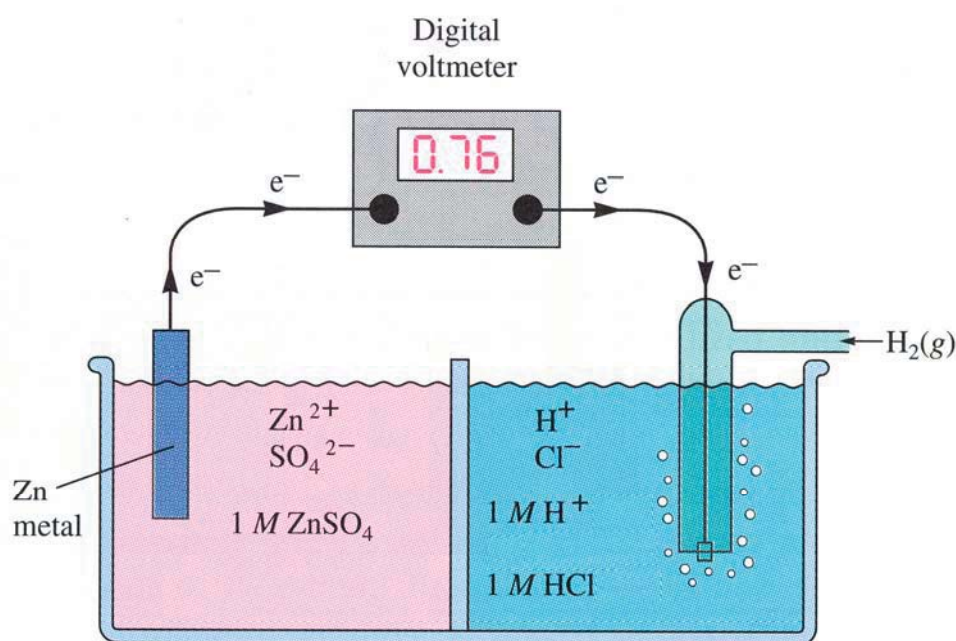
**Figure 6- 2: Galvanic cell**

Schematic setup of a galvanic cell consisting of a zinc electrode/ ZnSO_4 solution and a platinum electrode/ HCL solution.

As it may be seen from the figure above the cell potential for the entire cell is observed to be 0.76 volt corresponding to the overall cell reaction:

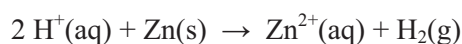

For the given galvanic cell the anode part contains zinc metal electrode with Zn^{2+} and SO_4^{2-} ions in an aqueous solution. The anode reaction is thereby given as:

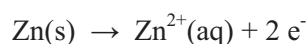

Through the anode reaction each zinc atom loses two electrons that migrate into the solution as Zn^{2+} ions.

The two electrons pass through the wire to the cathode solution where the following reaction takes place:

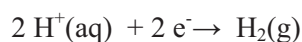

The cathode consists of platinum which is an inert conductor in contact with the 1 M H^+ ions surrounded by hydrogen gas at 1 atm . Such an electrode is called a standard hydrogen electrode which per definition has a half cell potential (symbolised at 298 K by the symbol of \mathcal{E}^0) of 0.00 volt . The figure below shows the principle in the build up of the standard hydrogen electrode.

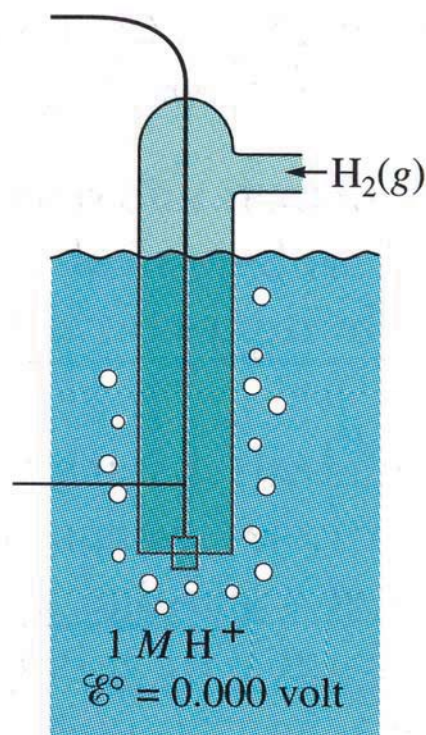
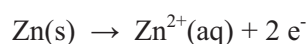

Figure 6- 3: The standard hydrogen electrode

The standard hydrogen electrode has per definition a half cell potential of 0.0 Volt at a H^+ concentration of 1.0 M .

Even though we are capable of measuring the galvanic cell potential by using the voltmeter placed between the two electrodes, it is not possible to ensure the two half cell potentials. We thereby have to define a half cell reaction that we may determine the other half cell potentials from. As mentioned above we have chosen to let the half cell potential for the standard hydrogen electrode be the zero point. On the basis of this it is possible to determine all the other half cell potentials. In the present case we may thereby say that the half cell reaction:



has the half cell potential of 0.76 volt as this is the value of the voltmeter when combined with the standard hydrogen half cell reaction.

The half cell potential (ε^0 values) corresponding to the given half cell reactions are sometimes referred to as standard reduction potentials and may be found in tables. Typically one of the half cell reactions should be turned around as each redox reaction contains one reduction reaction and one oxidation reaction. This means that one of the signs from the table must be turned around. Further may the half cell reaction from the table typically be multiplied with an integer in order to make sure that the number of electrons fits the number of consumed electrons from the overall cell reaction. These integer multiplications are associated with the determination of the free energy of Gibbs for a half cell reaction:

$$\Delta G^0 = -z \cdot F \cdot \varepsilon^0 \quad (6-2)$$

ΔG^0 denotes the change in standard Gibbs energy while z denotes the number of transferred electrons for the half cell reaction. The Faraday constant is denoted F . ΔG is often used to determine whether or not a reaction runs spontaneously. The total value of ΔG for an electrochemical reaction is determined as the sum of ΔG for the two half cell reactions. If ΔG is less than zero the reaction runs spontaneously. If ΔG is larger than zero energy must be added to the system in order to let the reaction take place. This we will look into in the following example:

Please click the advert

CHALLENGE YOURSELF

WWW.STUDYINSWEDEN.SE

Si.
Swedish Institute

Today's job market values ambitious, innovative, perceptive team players. Swedish universities foster these qualities through a forward-thinking culture where you're close to the latest ideas and global trends.

Whatever your career goals may be, studying in Sweden will give you valuable skills and a competitive advantage for your future. www.studyinsweden.se

Download free books at BookBooN.com

Example 6- E:*Calculation of cell potential and spontaneity*

We are informed that a galvanic cell consists of the following two half cell reactions:

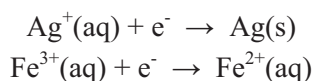

From a table we have the following reduction potentials:

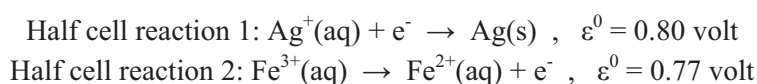

We wish to determine which one of the following two reactions that runs spontaneously and what the corresponding standard cell potential is:

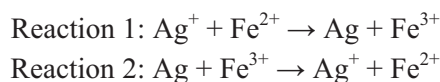

In order to settle this question ΔG^0 for the two half cell reactioner must be determined using equation (6-2):

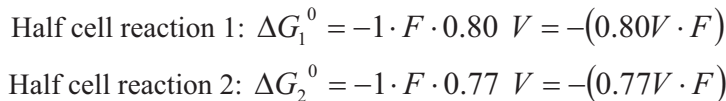

Now ΔG^0 for the reaction 1 and 2 may be determined at appropriate combination of ΔG_1^0 and ΔG_2^0 corresponding to the half cell reactions:

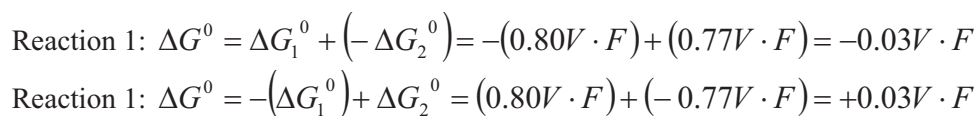

A spontaneous reaction runs only when ΔG^0 is less than 0 where reaction 1 is the reaction that runs in the galvanic cell as shown in figure 6-4. The standard potential of the cell is calculated on the basis of the determined value of ΔG^0 (equation (6-2)):

$$\begin{aligned}\text{Ag}^+ + \text{Fe}^{2+} &\rightarrow \text{Ag} + \text{Fe}^{3+} \\ \Delta G^0 = -z \cdot F \cdot \varepsilon^0 &\Leftrightarrow \varepsilon^0 = \frac{-\Delta G^0}{z \cdot F} = \frac{-(-0.03\text{V} \cdot F)}{1 \cdot F} = 0.03\text{V}\end{aligned}$$

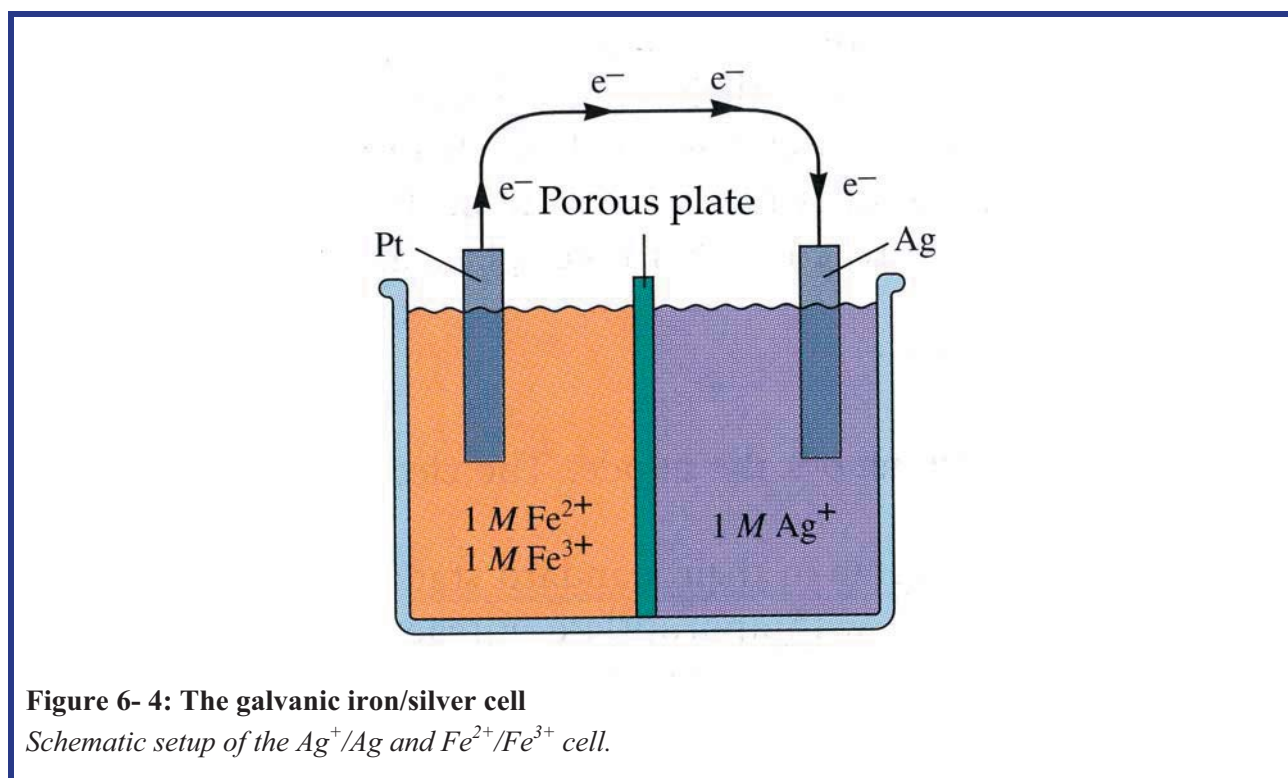

6.4 Concentration dependency of cell potentials

So far we have only looked at galvanic cells under standard conditions. Nevertheless cell potentials depend on the concentration of the ions that are in the half cells. E.g. the following overall cell reaction:

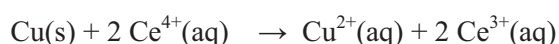

has a cell potential of 1.36 at 298 K where all ions are in 1 M concentration. Are the conditions not the standard ones (concentration = 1.0 M, temperature = 298 K) the potential of the cell may be different. Is the concentration of Ce^{4+} e.g. larger than 1 M the reaction, according to the principles of Le Chatelier's, will increase to the right and thereby increase the driving force of the cell. The cell potential will thereby increase.

The dependence of concentration for the cell potential at 298 K is given by the Nernst equation (named after the German chemist Hermann Nernst) given as:

$$\mathcal{E}_{cell} = \mathcal{E}_{cell}^0(\text{Standard conditions}) - \frac{0.0592}{z} \log Y \quad (6-3)$$

where Y is the reaction fraction found from the overall reaction equation and z is the number of transferred electrons in the overall reaction equation. We will look further into the application of the Nernst equation in the following example.

Example 6- F:

The use of the Nernst equation to determine the cell potential

We have been informed that a galvanic cell has the following two half cell reactions:

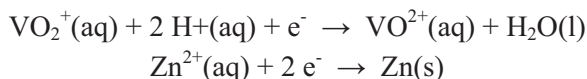

where $T = 298 \text{ K}$, $[\text{VO}_2^+] = 2.0 \text{ M}$, $[\text{VO}^{2+}] = 1.0 \cdot 10^{-2} \text{ M}$, $[\text{H}^+] = 0.50 \text{ M}$, $[\text{Zn}^{2+}] = 1.0 \cdot 10^{-1} \text{ M}$ and we wish to determine the potential of the cell. As it may be seen we do not have standard conditions in the cell. The figure below gives a sketch of the system:

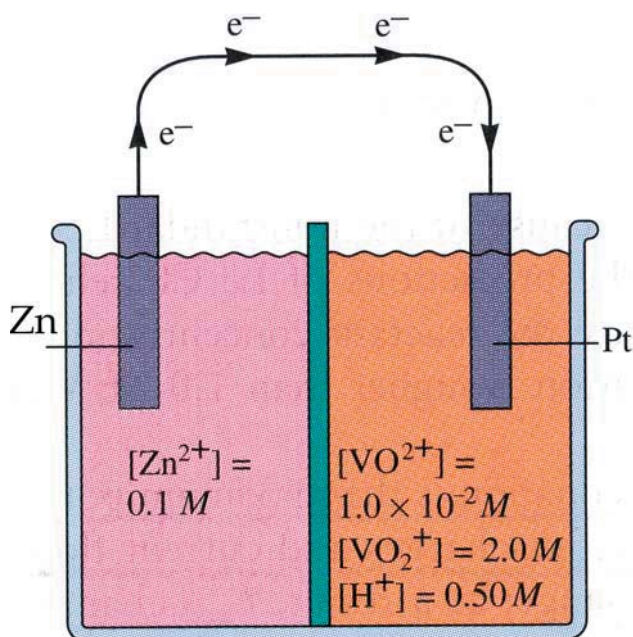
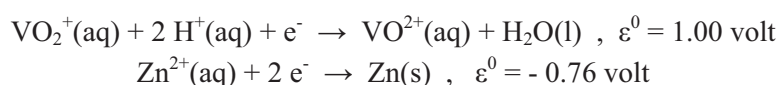

Figure 6- 5: Zinc/vanadium galvanic cell

Schematic setup of the Zn^{2+}/Zn and $\text{VO}^{2+}/\text{VO}_2^+$ cell.

From a table we have the following reduction potentials corresponding to the following reactions:



As earlier mentioned there has to be a reducing as well as an oxidising reaction and as the overall potential of the cell has to be positive the overall reaction must be:

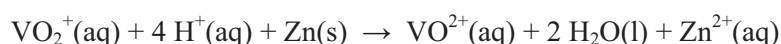

The total potential of the cell may be found as:

$$\varepsilon^0(\text{cellen}) = 1.00 \text{ V} + (-0.76 \text{ V}) = 1.76 \text{ V}$$

This is the value that we expect to measure if we had placed a voltmeter between the two electrodes in the galvanic cell and there had been standard conditions in the half cells. There are nevertheless not standard

conditions as the concentrations are different from 1 M. We will thereby use the Nernst equation:

$$\mathcal{E}_{\text{celle}} = \mathcal{E}^0_{\text{celle}} - \frac{0.0592}{z} \log Y$$

In the present case $z = 2$ as there is transferred 2 electrons in the reaction above. Y is in this case given as:

$$Y = \frac{[\text{Zn}^{2+}] \cdot [\text{VO}^{2+}]^2}{[\text{VO}_2^+]^2 \cdot [\text{H}^+]^4} = \frac{[1.0 \cdot 10^{-1}] \cdot [1.0 \cdot 10^{-2}]^2}{[2.0]^2 \cdot [0.50]^4} = 4.0 \cdot 10^{-5}$$

We thereby get the overall cell potential as::

$$\begin{aligned} \mathcal{E}_{\text{celle}} &= \mathcal{E}^0_{\text{celle}} - \frac{0.0592}{z} \log Y \Rightarrow \\ \mathcal{E}_{\text{celle}} &= 1.76 \text{ V} - \frac{0.0592}{2} \log 4.0 \cdot 10^{-5} = 1.89 \text{ V} \end{aligned}$$

The Nernst equation may also be used to calculate equilibrium constants which are often useful. This we will look into in the following example:

Always aiming for higher ground.
Just another day at the office for a Tiger.

Join the Accenture High Performance Business Forum

On Thursday, April 23rd, Accenture invites top students to the High Performance Business Forum where you can learn how leading Danish companies are using the current economic downturn to gain competitive advantages. You will meet two of Accenture's global senior executives as they present new original research and illustrate how technology can help forward thinking companies cope with the downturn.

Visit student.accentureforum.dk to see the program and register

Visit student.accentureforum.dk

• Consulting • Technology • Outsourcing

High performance. Delivered.

© 2009 Accenture. All rights reserved.

Please click the advert

Example 6- G:

The use of the Nernst equation to calculate equilibrium constants

We have a galvanic cell consisting of the following two half cell reactions:

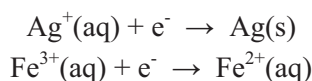

We wish to determine the equilibrium constant K for the overall cell reaction. At equilibrium the reaction fraction for the cell reaction Y is equal to the equilibrium constant for the cell reaction which is why we may be able to use the Nernst equation to determine the value for K . When there is equilibrium in a galvanic cell no transfer of electrons takes place between the two half cell which is why $\varepsilon_{\text{celle}}^0 = 0$.

From tables we have the following reduction potentials corresponding to the following reactions:

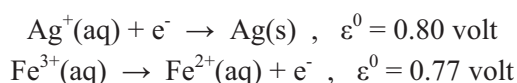

As mentioned earlier it is necessary that the potential of the cell is positive (meaning that ΔG is negative – please refer to equation (6-2)). In order for the cell reaction to be able to proceed the reaction between iron(II) and iron(III) ions has to run backwards. The overall cell reaction has to be (which was also shown in example 6-E) with corresponding equilibrium expression:

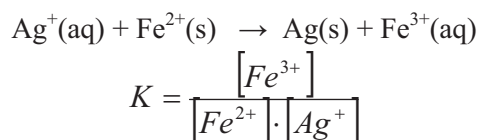

As mentioned it is the size of this equilibrium constant K , that we wish to determine in order to be able to predict something about the equilibrium. The total standard potential of the cell is determined to be:

$$\varepsilon^0(\text{cellen}) = 0.80 \text{ V} + (-0.77 \text{ V}) = 0.03 \text{ V}$$

From the Nernst equation the equilibrium constant is found in the following manner ($z = 1$ as there is only one electron transferred in the overall cell reaction):

$$\begin{aligned}\varepsilon_{\text{celle}} &= \varepsilon_{\text{celle}}^0 - \frac{0.0592}{z} \log Y \Leftrightarrow (\text{ved ligestv} \text{et}) 0 = \varepsilon_{\text{celle}}^0 - \frac{0.0592}{z} \log K \Leftrightarrow \\ \log K &= \frac{z \cdot \varepsilon_{\text{celle}}^0}{0.0592} = \frac{1 \cdot 0.03 \text{ V}}{0.0592} \Rightarrow K = 3.2 \text{ M}\end{aligned}$$

As the equilibrium constant is 3.2 M the equilibrium must be to the right under the given conditions.

6.5 Batteries

One of the well-known applications of the electrochemistry is the use of galvanic cells in batteries. A battery is in principle just a group of galvanic cells in series, in which the potential of each cell is summed up to give a higher voltage across the battery. Batteries are used for a variety of purposes in our daily life. There are several different principles of how a battery may be build. In the following examples we will look at three types of batteries.

Please click the advert



it's an **interesting** world

Get under the skin of it.

Graduate opportunities
Cheltenham | £24,945 + benefits

One of the UK's intelligence services, GCHQ's role is two-fold: to gather and analyse intelligence which helps shape Britain's response to global events, and, to provide technical advice for the protection of Government communication and information systems. In doing so, our specialists – in IT, internet, engineering, languages, information assurance, mathematics and intelligence – get well beneath the surface of global affairs. If you thought the world was an interesting place, you really ought to explore our world of work.

www.careersinbritishintelligence.co.uk

Applicants must be British citizens. GCHQ values diversity and welcomes applicants from all sections of the community. We want our workforce to reflect the diversity of our work.



Example 6- H:*Lead battery*

The lead battery is used primarily in cars where they deliver current to the start engine. The reason for this widely use through many years is that lead batteries work well with good performance at typical outdoor temperatures. The anode in the lead battery is the lead electrode while the cathode typically consists of a lead electrode covered with lead oxide. Both electrodes are placed in an electrolytic solution of sulphuric acid. The following half cell reaction takes place at the anode:



while the following half cell reaction takes place at the cathode:

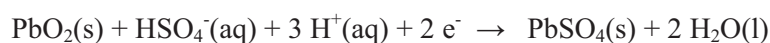

Hereby the total overall cell reaction is:



A typical lead battery for the use in cars has six cells in series. As each cell each gives 2 volt the total voltage becomes 12 volt.

Please note from the overall cell reaction that sulphuric acid is used in the reaction and the battery is hereby slowly discharged. Hereby the density of the electrolytic solution changes and one of the ways to determine the condition of the battery is to measure the density of the electrolytic solution. The solid lead sulphate that is formed during the cell reaction is set on the surfaces of the electrodes.

The lead battery may be recharged by passing a current of electrons in the opposite direction of the cell reaction above. This happens continuously while the car is driving as the energy for the recharge is generated by the combustion reaction in the engine of the car. The figure below shows the principle in the set-up of the lead battery.

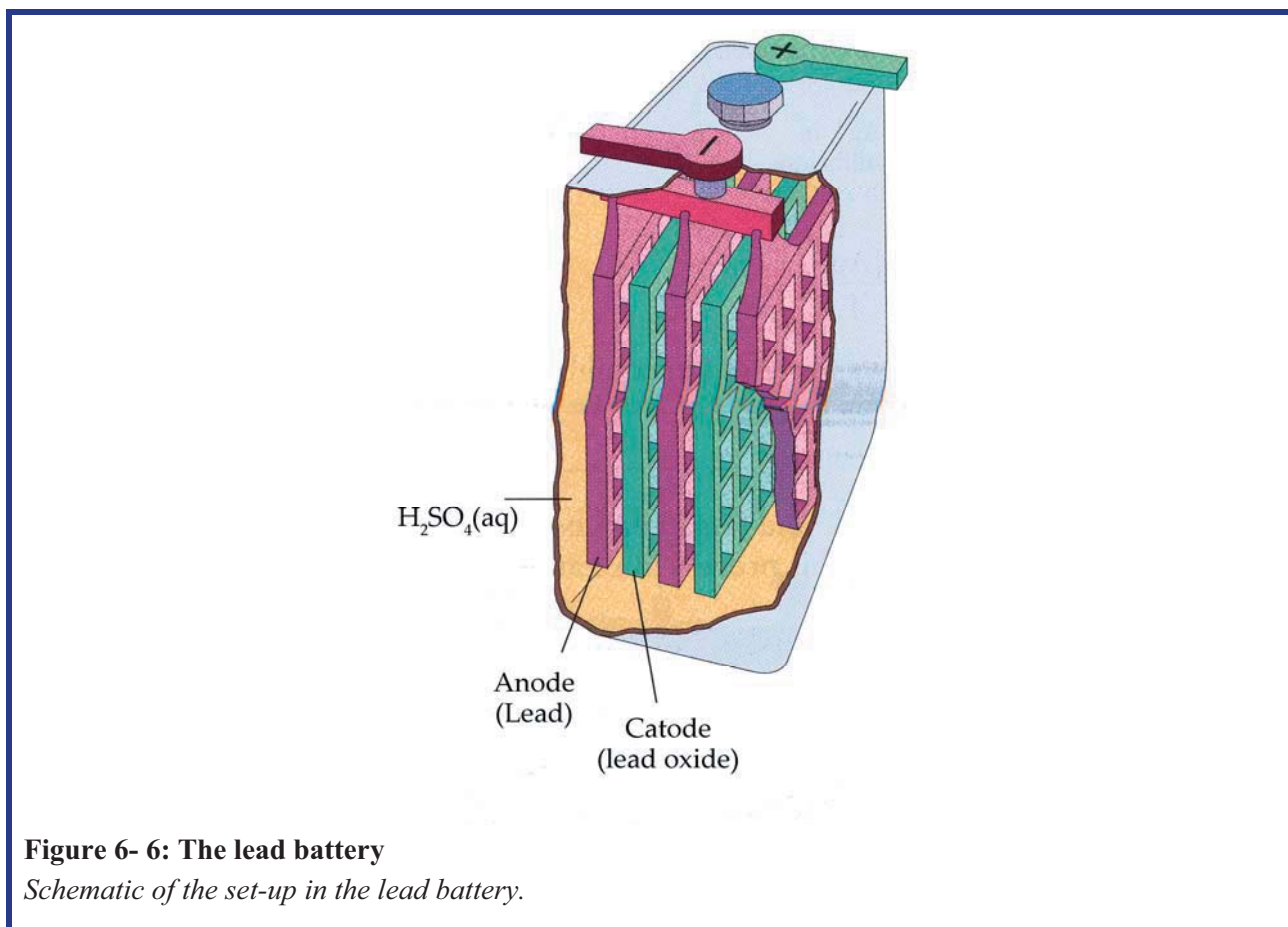

Figure 6- 6: The lead battery

Schematic of the set-up in the lead battery.

Please click the advert

CHALLENGE YOURSELF

WWW.STUDYINSWEDEN.SE

Today's job market values ambitious, innovative, perceptive team players. Swedish universities foster these qualities through a forward-thinking culture where you're close to the latest ideas and global trends.

Si.
Swedish Institute

Whatever your career goals may be, studying in Sweden will give you valuable skills and a competitive advantage for your future. www.studyinsweden.se

Download free books at BookBooN.com

Example 6- I:*Dry cell batteries*

For the use in watches and pocket calculators small galvanic cells are used. There are numerous different types of dry cell batteries. In an acid dry cell battery the inner shell is made of zinc functioning as anode and a carbon rod in the centre of the cell, being in contact with solid MnO_2 and solid NH_4Cl functioning as cathode. The following half cell reaction takes place at the anode:

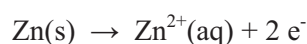

The following half cell reaction takes place at the cathode:

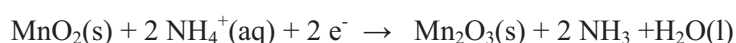

Such a galvanic cell produces roughly 1.5 volt which is why it is necessary to insert several dry cell batteries in series to achieve sufficient voltage to run a pocket calculator. The figure below shows the principle of the set-up of such an acid dry cell battery.

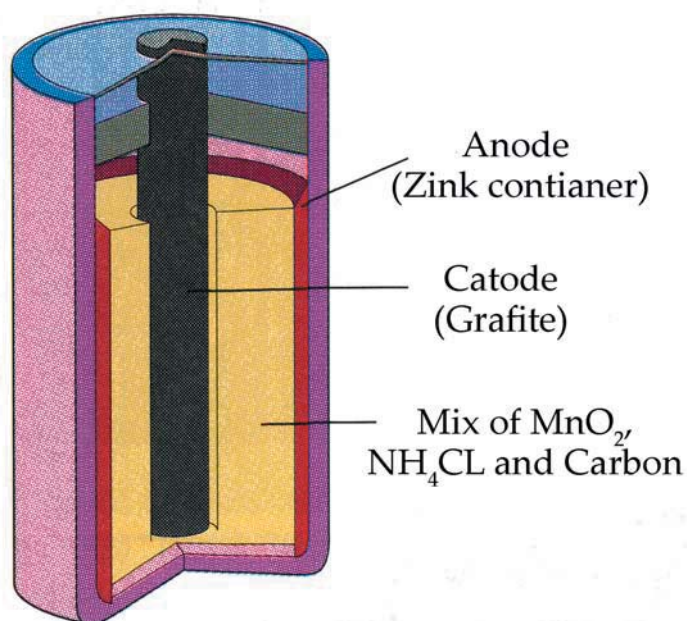

Figure 6- 7: The dry cell battery

Set-up of the acid dry cell battery.

A more modern version of the dry cell battery is the *alkaline* version where the solid NH_4Cl is replaced by KOH and NaOH . Hereby the following half cell reaction takes place at the anode:



while the following half cell reaction takes place at the cathode:

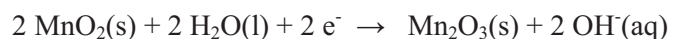

In respect to the acid dry cell battery the life time for the alkaline battery is significantly longer as zinc corrodes slower in basic than in an acid environment.

Another type of battery is the mercury battery often formerly used in pocket calculators. The mercury battery has a zinc electrode while mercury oxide HgO are oxidised in the basic environment consisting of typically KOH and Zn(OH)₂. The figure below shows the set-up of the mercury dry cell battery.

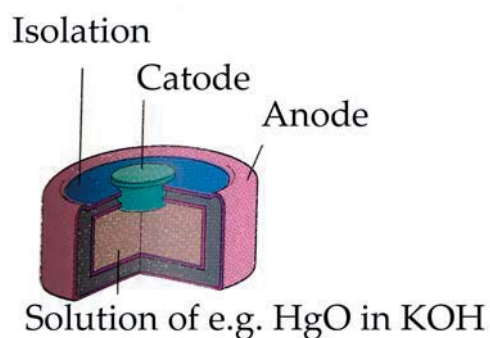

Figure 6- 8: Mercury battery

Sketch of the set-up of a basic mercury dry cell battery.

Example 6- J:*Fuel cells*

A fuel cell is in principle a galvanic cell where the reactants are added continuously to the system. In order to illustrate the principle in a fuel cell reaction we will look at the exothermal reaction between methane and oxygen which is a redox reaction:



The energy that is developed by the process is normally used to heat up houses or to run engines. In a fuel cell the energy may be extracted as electrical energy directly as the transferred electrons may be extracted directly. Similarly, the simple reaction hydrogen and oxygen:

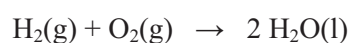

may be used to extract current through a fuel cell set-up as sketched in the figure below:

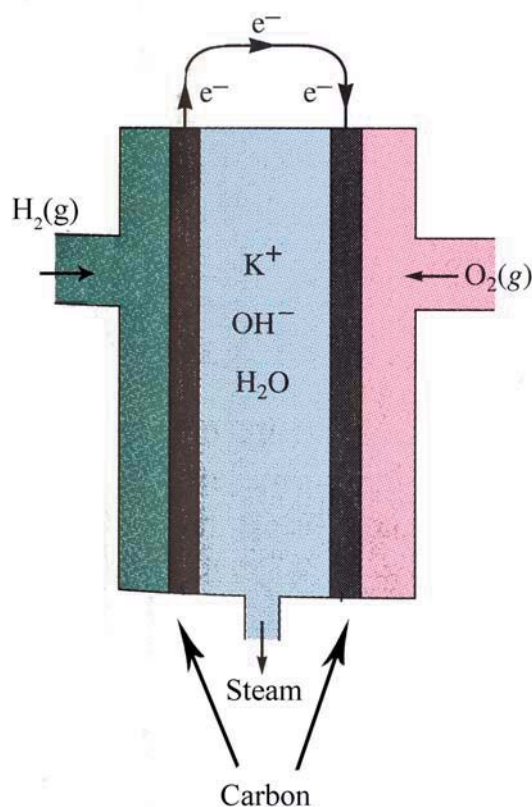
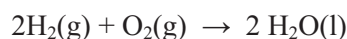

Figure 6- 9: Fuel cell

Sketch of the principle set-up in a fuel cell.

The following half cell reaction takes place at the anode:



whereas the following half cell reaction takes place at the cathode:

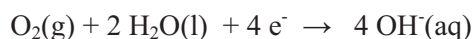

In recent years the research in fuel cells has increased significantly. One of the reasons for this is that the reactions in fuel cells do not involve environmentally dangerous species. What is of further importance is that fuel cells involve reactions where CO_2 is not produced.

6.6 Corrosion

Well-known phenomena as corrosion of e.g. copper roofs are closely related to the electrochemistry. Because corroded metal as e.g. iron loses its strength corrosion chemistry has great practical importance. Metals are especially exposed to corrosion as metals are easily oxidised. From tables of standard reduction potentials one will see that with the exception of noble metals as e.g. gold the standard reduction potentials of common metals are lower than for oxygen. This means that the oxidation of most metals is a spontaneous reaction even though not metals are equally oxidised in the presence of oxygen.

Even though many metals ought to be corrosive in the presence of oxygen it is actually seldom the case. This is caused by the fact that many metals build a small oxide layer on the outside of the metal that help to prevent corrosion. This we will look into in the following example.

Example 6- K:*Aluminium oxide as protection against corrosion*

With a standard reduction potential of -1.7 volt aluminium ought to corrode relatively easy by being exposed to water and oxygen. Nevertheless a thin layer of aluminium oxide Al_2O_3 is formed by contact with oxygen as sketched on the figure below:

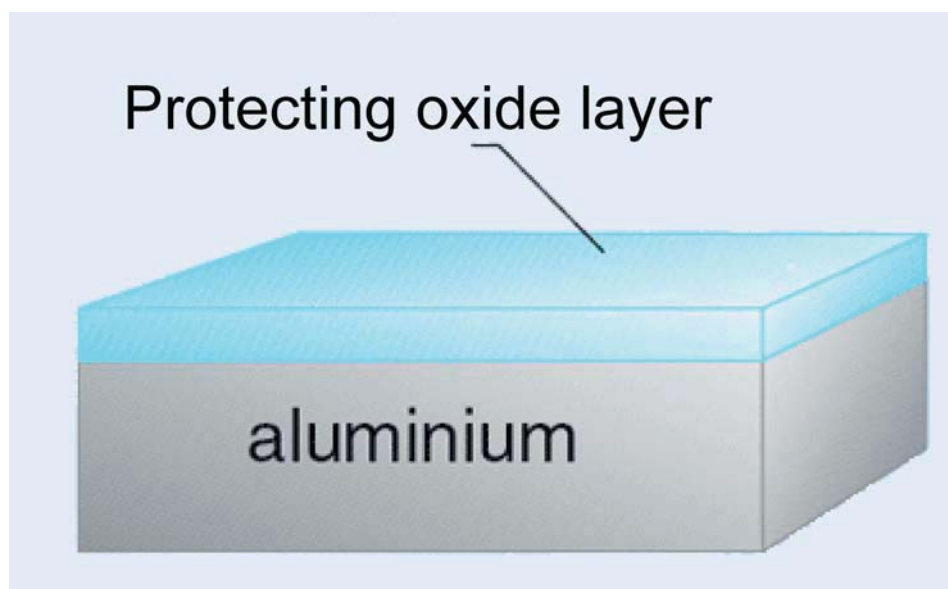
**Figure 6- 10: Protecting oxide layer**

Formation of aluminium oxide on aluminium metal.

Whereas the oxidation of aluminium metal has a standard reduction potential of -1.7 volt the oxidation of Al_2O_3 has only a standard reduction potential of -0.6 volt making aluminium oxide almost as corrosion resistant as the noble metal gold.

Iron forms also an oxide layer (better known as rust) on the surface but on the contrary to aluminium oxide the layer does not have the same adhesion and thereby peels off. Hereby new iron metal may be exposed to oxygen and water whereby the corrosion process may continue. This is the subject for the following example:

Example 6- L:*Aluminium oxide as protection against corrosion*

Iron in the form of steel is widely used as building material for houses, bridges, cars and more. Therefore corrosion of iron is a phenomenon that has great practical application.

Steel is a mixed product where the main part is iron atoms plus other metals and carbon. This means that the surface of steel is irregular and such inhomogenities means that the surface of steel is easily oxidised. In such anodic regions each iron atom gives 2 electrons in the following reaction:

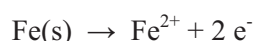

The given electrons by this process are transported to the cathodic regions of the steel following the earlier stated principles of transport of electrons that we have looked at.

In such cathodic regions on the steel Fe^{2+} ions react with the oxygen in the air and forms rust which is chemically hydrated iron (III) oxide of variable composition. The reaction may simplified be written as:

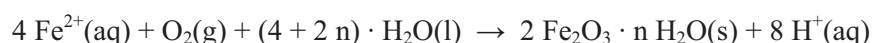

Due to the transport of electrons from the anodic regions to the cathodic regions on the steel surface the rust will often form a distance away from the site where the iron atoms are oxidised. This is sketched in the figure below:

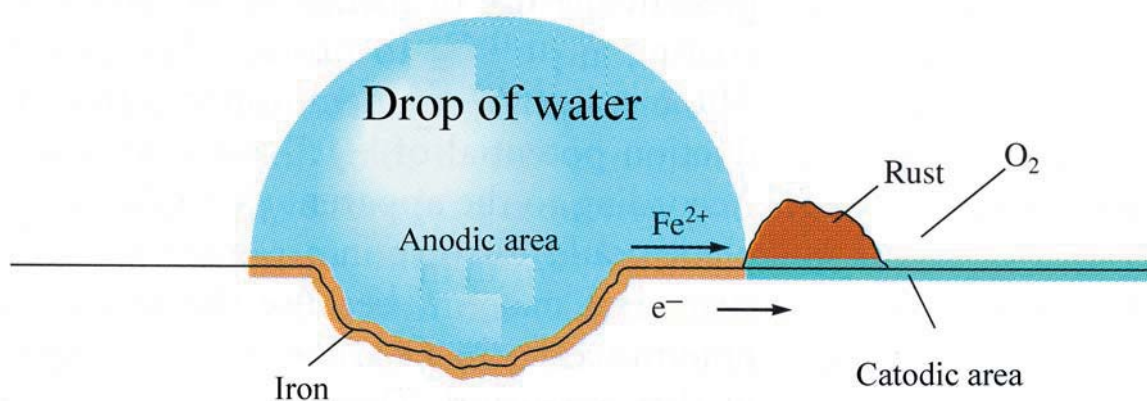

Figure 6- 11: Corrosion of aqueous environment

The electrochemical corrosion of a steel surface in the presence of water.

But what can be done in order to increase the life time for a steel surface? One of the possibilities is to paint the steel surface in order to hinder oxygen and water molecules from getting into contact with the iron atoms. One of the other possibilities is to treat the steel with a more corrosion preventive metal. E.g. it is common to treat the steel with zinc in a so-called galvanisation process closely related to *electrolysis*,

which is the subject for the following section. The advantage of coating the steel with zinc is that zinc does not form an oxide layer.

Zinc is easier to oxidise than iron which may be seen by the comparison of the equations below:

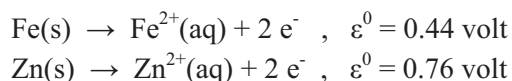

This means that zinc sacrifices itself for the sake of iron meaning that the zinc atoms will be oxidised prior to the iron atoms thereby expanding the life time of the steel.

6.7 Electrolysis

We have seen previously how a galvanic cell may produce current from a chemical reaction. Similarly we shall see in this section how the opposite reaction may be used to make a chemical reaction occur. Such a process is called electrolysis which involves the addition of current in order to make the chemical reaction occur having otherwise a negative cell potential. This means that the reaction will not take place spontaneously. We looked briefly into this principle in the example with the lead battery earlier in this chapter but in this section we will go deeper into the phenomenon of electrolysis.

In order to illustrate the difference between a galvanic cell and an electrolytic cell we will start with the galvanic cell in the figure below:

Please click the advert

Brain power

By 2020, wind could provide one-tenth of our planet's electricity needs. Already today, SKF's innovative know-how is crucial to running a large proportion of the world's wind turbines.

Up to 25 % of the generating costs relate to maintenance. These can be reduced dramatically thanks to our systems for on-line condition monitoring and automatic lubrication. We help make it more economical to create cleaner, cheaper energy out of thin air.

By sharing our experience, expertise, and creativity, industries can boost performance beyond expectations. Therefore we need the best employees who can meet this challenge!

The Power of Knowledge Engineering

Plug into The Power of Knowledge Engineering.
Visit us at www.skf.com/knowledge

SKF

Download free books at BookBooN.com

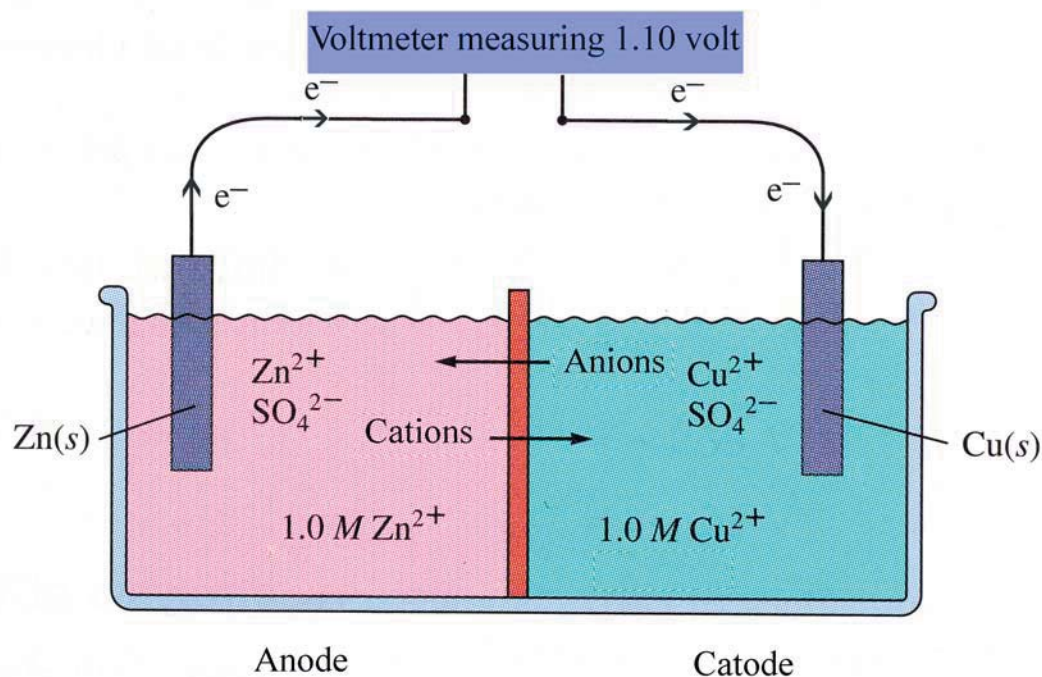
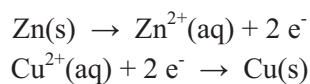

Figure 6- 12: Zinc/cobber galvanic cell

The cell is based on the spontaneous reaction between $Zn(s)$ and Cu^{2+} ions.

The reaction in the galvanic runs spontaneously by which the following half cell reaction take place at the anode and cathode respectively:



The opposite reaction of the reaction in the galvanic cell may be done in terms of adding current into the opposite direction of the spontaneous. The added current has to be larger than 1.10 volt which is the standard potential for the cell in Figure 6-12. Such a set-up is called an electrolytic cell and for the present case such a cell may be seen from the figure below:

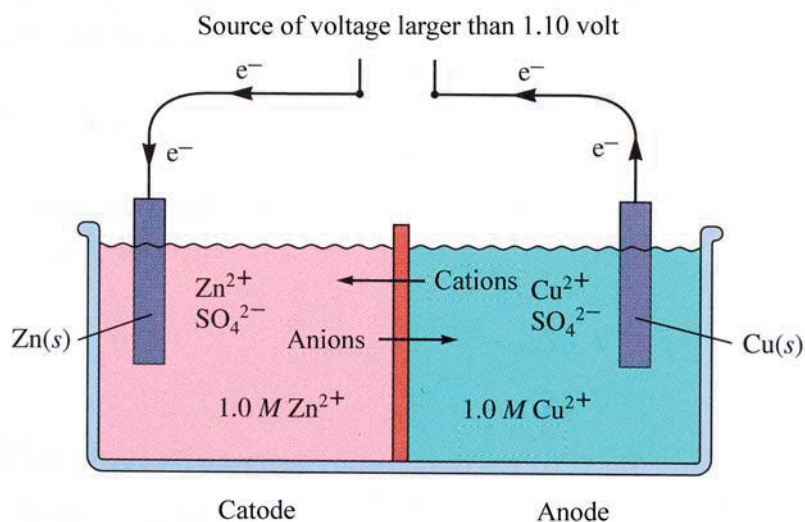

Figure 6- 13: Zinc/cobber electrolytic cell

The added current makes the reaction between $Zn^{2+}(aq)$ ions and $Cu(s)$ take place.

By adding current to the electrolytic cell one forces the non-spontaneous reaction to proceed. This principle is widely used to protect metal surfaces from corrosion as earlier emphasised.

The electrolysis reaction may also be sued for other purposes that to coat metal surfaces. This we will look into in the following example.

Trust and responsibility

NNE and Pharmaplan have joined forces to create NNE Pharmaplan, the world's leading engineering and consultancy company focused entirely on the pharma and biotech industries.

Inés Aréizaga Esteva (Spain), 25 years old
Education: Chemical Engineer

– You have to be proactive and open-minded as a newcomer and make it clear to your colleagues what you are able to cope. The pharmaceutical field is new to me. But busy as they are, most of my colleagues find the time to teach me, and they also trust me. Even though it was a bit hard at first, I can feel over time that I am beginning to be taken seriously and that my contribution is appreciated.

Please click the advert



NNE Pharmaplan is the world's leading engineering and consultancy company focused entirely on the pharma and biotech industries. We employ more than 1500 people worldwide and offer global reach and local knowledge along with our all-encompassing list of services.
nnepharmaplan.com

nne pharmaplan®

Example 6- M:*Electrolysis of water*

We have seen earlier how hydrogen and oxygen may be combined and spontaneously form water molecules and that this reaction produces energy which may be used in fuel cells. The opposite process where hydrogen and oxygen are formed from water molecules is not spontaneous but requires an electrolytic process. The following half cell reaction takes place at the anode:

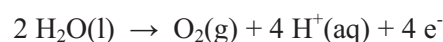

with corresponding half cell potential of $\varepsilon^0 = 1.23$ volt while that following half cell reaction takes place at the cathode:

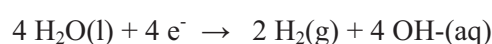

having a half cell potential of $\varepsilon^0 = -0.83$ volt. Hereby the total overall cell reaction becomes:

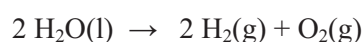

and the total cell potential thereby $\varepsilon^0 = -2.06$ volt. These potential calculations requires of cause that there is a concentration of H^+ ions of 1 M in the half cell with the anode while there is a concentration of OH^- ions of 1 M in the half cell with the cathode. This is naturally not the case in pure water with $\text{pH} = 7.0$ which is why we expect a potential for the overall process of -1.23 volt.

6.8 Summing up on chapter 6

We have seen in this chapter of important parts of the electrochemistry. We started by looking at the basic principles of oxidation- and reduction reactions and introduced the levels of oxidation and the rules for giving levels of oxidation. This was used to balance redox-reactions.

Further we looked at galvanic cells where it was possible to extract electrical energy from chemical reactions. We looked into cell potentials and standard reduction potentials which are both central and necessary for the electrochemical calculations. We also looked at concentration dependence of cell potentials and introduced the Nernst-equation stating the combination of the reaction fraction and cell potentials. The use of the Nernst equation was presented through examples where er also saw how the equation may be used to determine equilibrium constants.

In order to highlight the application of the chemistry in practice we went through three types of batteries being the lead battery, the dry cell battery and the fuel cell. We further looked at corrosion and saw through examples on how steel may be protected from corrosion in terms of electrochemical treatment with a scarifying other metal. Lastly we looked at electrolysis of metal ion solutions and the electrochemical fractioning of water molecules.

7. Concluding remarks

We have in this book dealt with central parts of the inorganic and applied chemistry as is introduced in the early parts of the engineering study. Through different examples we have seen different areas of the chemistry that forms the basis for a broader and greater understanding of chemical and technical aspects of chemistry that is presented for the engineering student in later stages of the study and career.

We have aimed at providing relevant examples making the theoretical parts easier to understand. Many places the theoretical parts are short followed by numerous examples. Focus has also been at practical applications of chemical principles as it is our belief that this puts the different parts of the chemical principles into a more relevant practical frame. It is our hope that the book will ease the transfer from the chemical education in high-school to the somewhat more advanced education at university.

December 2006

Peter Dybdahl Hede and Søren Prip Beier

Please click the advert



THE MILKWAY
LAUNCHING GRADUATE CAREERS

MILKROUND SYSTEM
Become a business star with internships, placements, graduate jobs & schemes from leading companies.
www.milkround.com

PLANET CAREER ADVICE
Inhabited by insights into business careers and orbited by application advice.

FIRST CONTACT
Get matched to top business employers via intelligent emails landing in your inbox.

Milkround.com: rated the #1 graduate recruitment website in the UK Graduate Careers Survey 2009 of 16,000 university finalists.

Milkround.com

Download free books at BookBooN.com